



TIME CLOCK WORLD

888 534-5994



900E

USER MANUAL



9000E

User's Manual



Lathem Time Corporation

WARNING

This equipment has been tested and found to comply with the limits for a Class A digital device, pursuant to Part 15 of FCC Rules. These limits are designed to provide reasonable protection against harmful interference when the equipment is operated in a commercial environment. This equipment generates, uses, and can radiate radio frequency energy and, if not installed and used in accordance with the instruction manual, may cause harmful interference to radio communications. Operation of this equipment in a residential area is likely to cause harmful interference in which case the user will be required to correct the interference at his or her own expense.

Caution: Changes or modifications not expressly approved by the party responsible for compliance could void the user's authority to operate the equipment.

THIS DIGITAL APPARATUS DOES NOT EXCEED THE CLASS A LIMITS FOR RADIO NOISE EMISSIONS FROM DIGITAL APPARATUS AS SET OUT IN THE RADIO INTERFERENCE REGULATIONS OF THE CANADIAN DEPARTMENT OF COMMUNICATIONS.

LE PRÉSENT APPAREIL NUMÉRIQUE N'ÉMET PAS DE BRUITS RADIOÉLECTRIQUES DÉPASSANT LES LIMITES APPLICABLES AUX APPAREILS NUMÉRIQUES DE CLASSE A PRÉSCRITES DANS LE RÈGLEMENT SUR LE BROUILLAGE RADIOÉLECTRIQUE ÉDICTÉ PAR LE MINISTÈRE DES COMMUNICATIONS DU CANADA.





Lathem Time Corporation





PRECAUTIONS







This user's manual is prepared for safe and proper use of the unit. Please follow all the instructions to avoid possible danger to yourself or others and damage to the unit.

Signs

Various warnings and cautions are provided throughout this manual along with signs. Remember each sign and its explanation listed below for your safety and proper operation of the unit.

 Warning	Improper handling may cause bodily accidents including death and serious injury.
 Caution	Improper handling may harm the human body or material.

 Improper handling may cause electric shock DANGER.	 "Must-Do" sign.
 DO NOT disassemble the unit.	 Be sure to remove the line cord plug from the outlet.
 "Don't" sign.	

 Warning	
	Do not disassemble the unit. There is a high voltage present inside, possibly leading to an electric shock.
	Do not modify the unit. Modifications may cause a fire and/or electric shock.
	If any anomaly occurs, for example, heat or smoke is generated or an odor is emitted, unplug the unit immediately and contact your dealer for servicing. There is a danger that further use may cause a fire or electric shock.
	Do not use any voltage of the power source other than designated. Do not share a single outlet with another plug. These may lead to fire or shock hazards.
	Do not damage, break, or modify the power cord. Do not put a heavy object on, pull, or forcefully bend the cord, either. These may damage the cord, possibly resulting in a fire or electric shock.



If foreign matter should get in the unit (including a piece of metal, water, or liquid), disconnect the plug from the outlet immediately and contact your dealer for servicing. There is a danger that further use may cause a fire or electric shock.



Do not plug or unplug the unit with a wet hand. You may get an electric shock.



Caution



Do not place the unit on an uneven or tilted surface. This may result in injuries due to the unit dropping or falling off.



Do not put a water-filled container or a metal object on top of the unit. If water is spilled or the metallic object slips inside, a fire or shock hazard may occur.



Do not install the unit in a humid or dusty environment. It may cause a fire or electric shock.



Do not place the unit near kitchen counter or humidifier. Oil, smoke, or steam generating from them may cause fire or shock hazards.



Do not yank the power cord to disconnect from the outlet. Hold the plug with your hand to do so, or the cord may be damaged, possibly leading to a fire or electric shock.



Remove the line cord plug from the outlet before transferring the unit, or it may damage the cord, possibly leading to a fire or electric shock.



Be careful not to contact the print head, as you may get hurt or burned.



Make sure to insert the power plug as far as it will go. Improper insertion of the plug may develop fire or shock hazards.



Do not insert or drop any other time cord than specified into the slot. Such misuse may cause a fire or electric shock.



If the unit should be dropped or the case be broken, unplug the unit and contact your dealer for servicing. Further use may lead to a fire or shock hazard.

Daily Care

For cleaning, turn the power off and wipe the case clean of dust and dirt with a dry cloth, etc.

Thank you for purchasing our time clock.
For safe and proper operation, please carefully read the manual before using the time clock and save it for reference.

Features:

Main applications: Payroll/job cost recorder or time stamp

- Quartz time clock
- Dot matrix printer
- Perpetual calendar
- Automatic daylight saving time
- Prints in 3 languages



- 12 or 24-hour format
- Regular minute, 1/10, 1/60, 1/100 or 5/100 of an hour
- 13 preprogramed comments
- Digital LCD display (Date, Hour, Minute, Day of the week indication)

Caution:

Avoid placing the unit in environments that are:

- humid or dusty.
- exposed to direct sunshine.
- subject to frequent or continuous vibrations.
- outside the temperature range between +25°F and 113°F (-5°C and 45°C).
- affected by chemicals or ozone.

Place the time clock close to the wall outlet so that it is easily accessible to disconnect.

Do not put a heavy object on the clock, or not forcefully press the cover of the clock. It may cause mechanism trouble and danger especially when the unit is hung on the wall.

BEFORE USING THE TIME CLOCK

Accessories



User's manual



Key



Wall-mount fittings
Screws (2 pcs.)

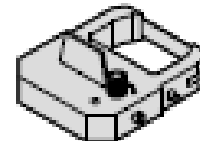

Ribbon cassette

Configuration

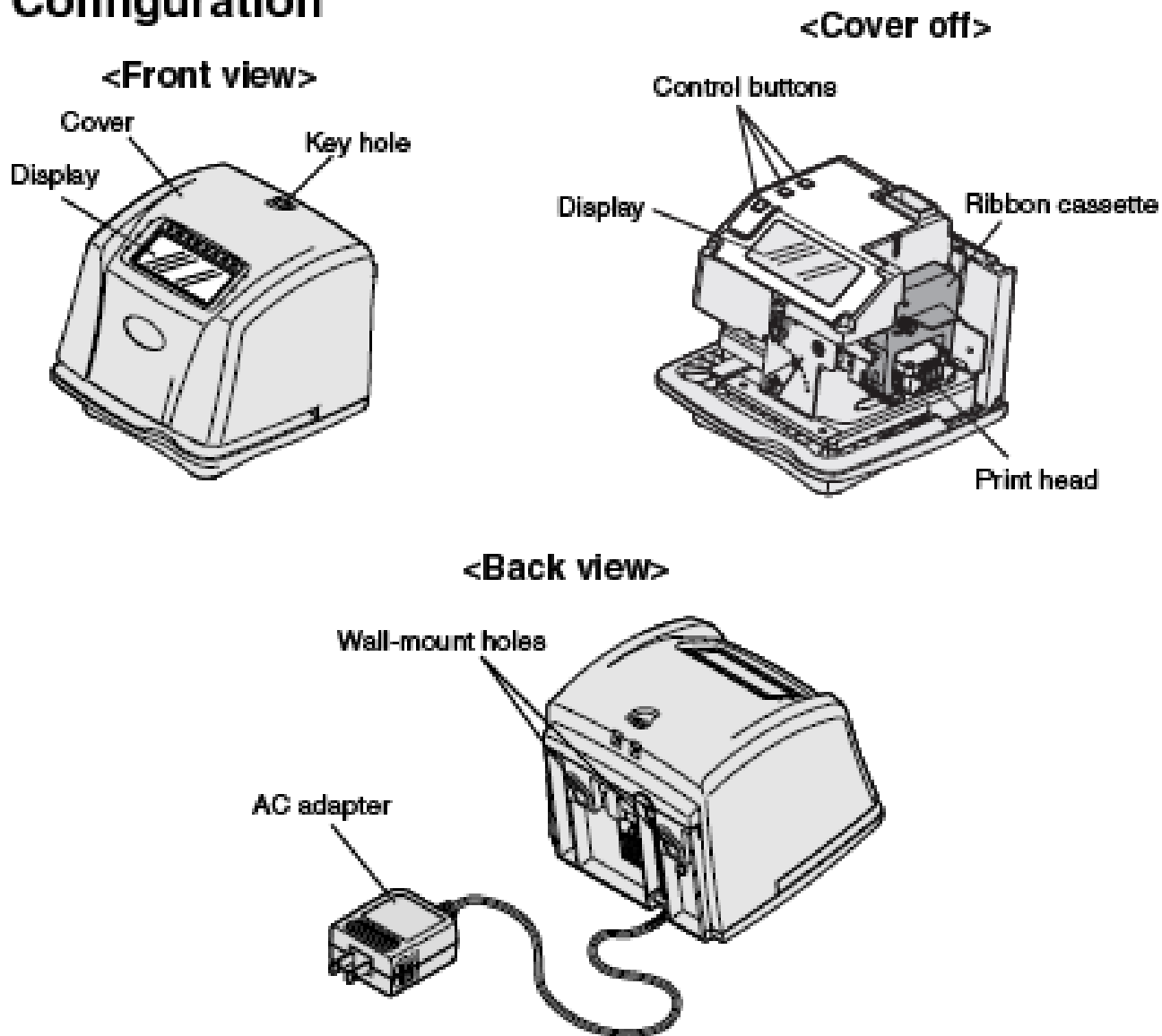

QUICK EASY SETUP

NOTICE: Install the **RIBBON CASSETTE** before you plug the AC adapter into the AC outlet.

To install the **RIBBON CASSETTE**, please refer to the step 3 and following steps in the "REPLACING THE RIBBON CASSETTE".

To setup your time clock, follow next steps:

Step 1

Unlock the key and remove the cover.

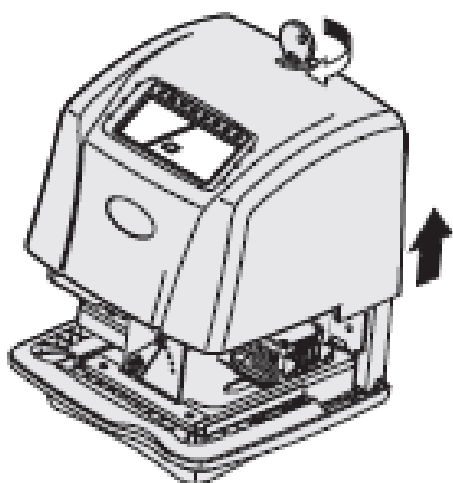

Step 2

Install the **RIBBON CASSETTE**, and plug the AC adapter into the time clock.

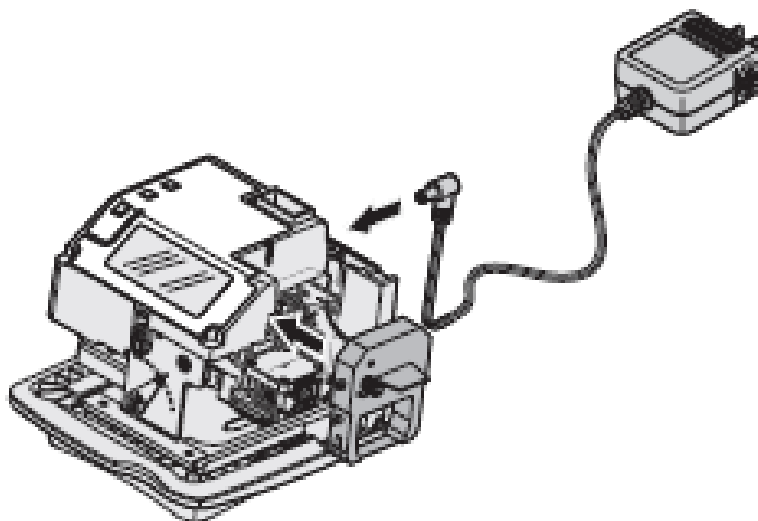

Step 3

Replace the cover.

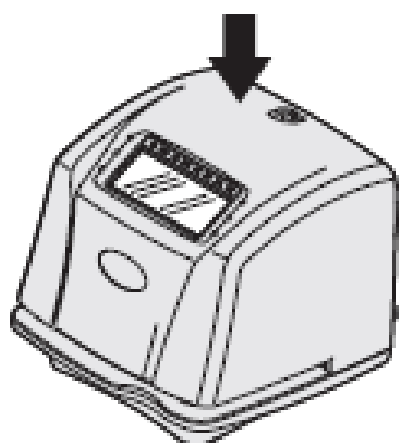

Step 4

Plug the AC adapter into the AC outlet and insert a card.

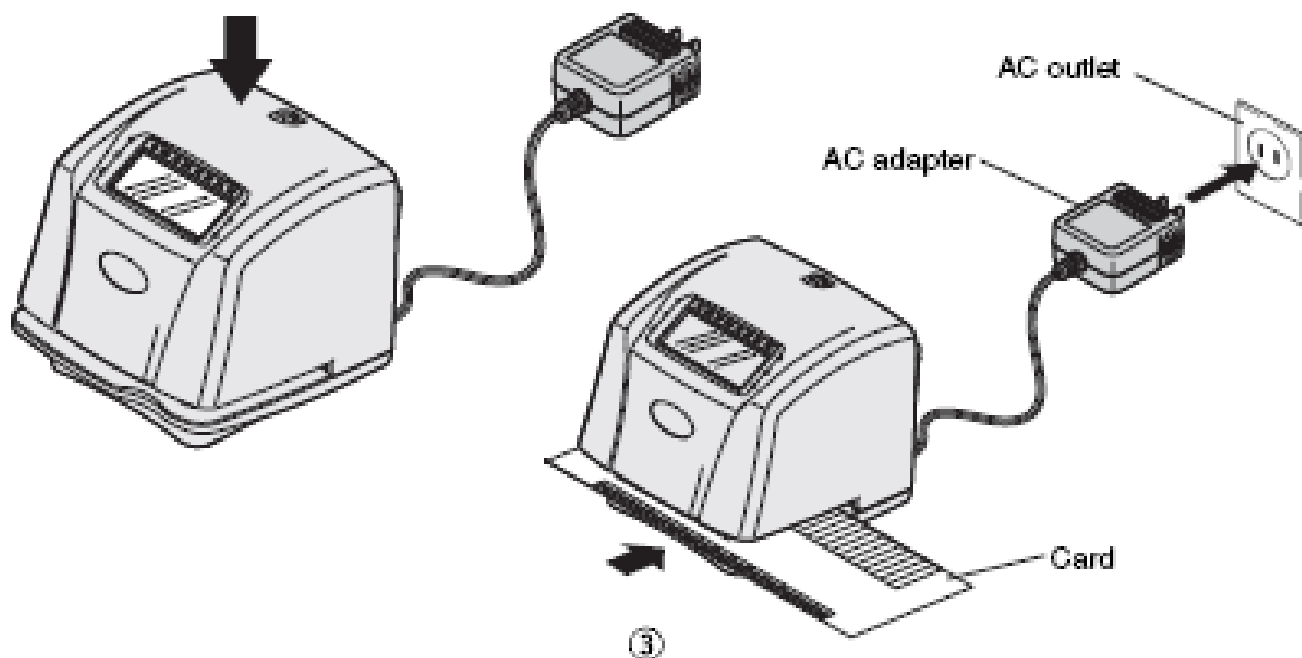

WALL MOUNTING

Caution: The supplied screws are intended for use on a thick wooden wall or wooden column. Do not use them on any other materials. The time clock may come off if used on other materials.

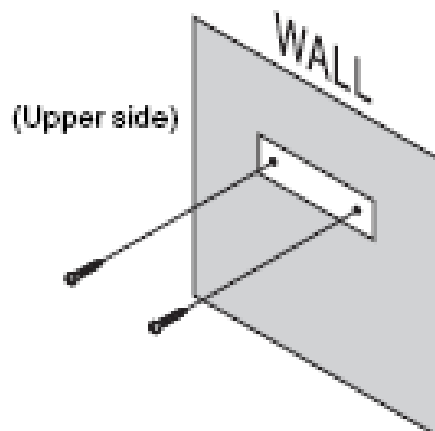

Step 1

Install the supplied wall-mount screws into a wall by using the template. Be sure to keep about 1/4" of the screw head away from the wall.

Please use the template attached to this manual.

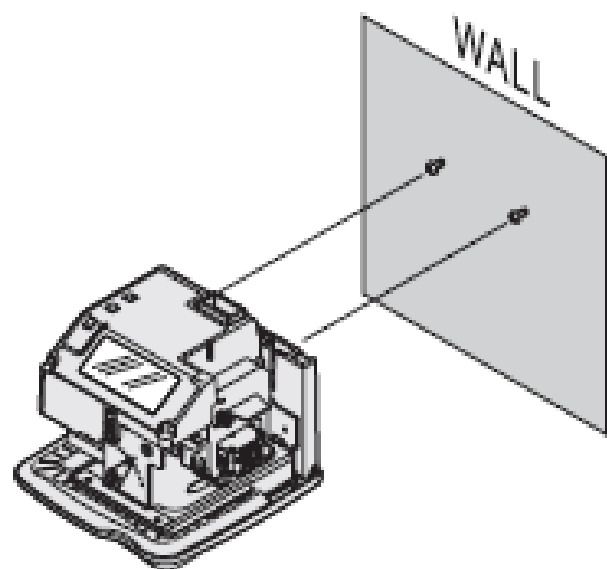

Step 2

Unlock the key and remove the cover. And then hang it on the wall.

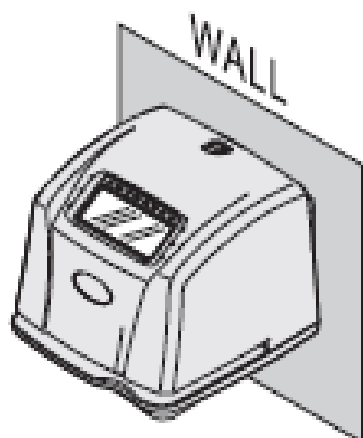

Step 3

Replace the cover.

REPLACING THE RIBBON CASSETTE

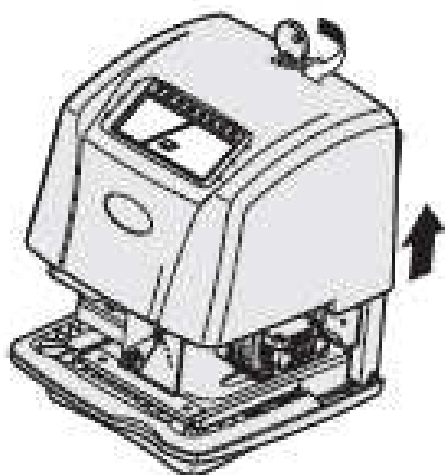

Step 1

Unplug the AC adapter from the AC outlet, and then unlock the key and remove the cover.

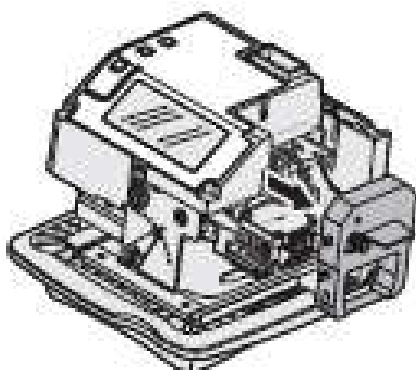

Step 2

Pick up the cassette and remove it.

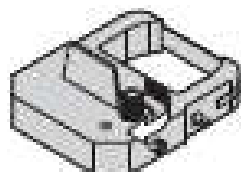

Step 3

Turn the knob of the new cassette in the direction of the arrow to tighten the ribbon.

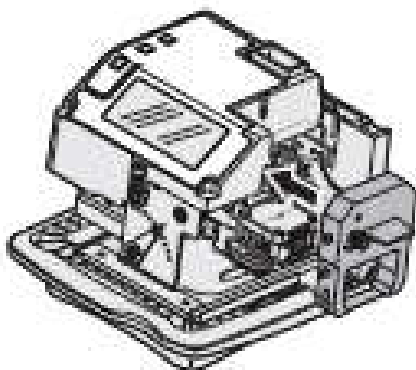

Step 4

Place the cassette inside the time clock as shown in the figure. Keep on pushing in the cassette until it snaps into place. If it is difficult to insert the cassette, try it while turning the knob.

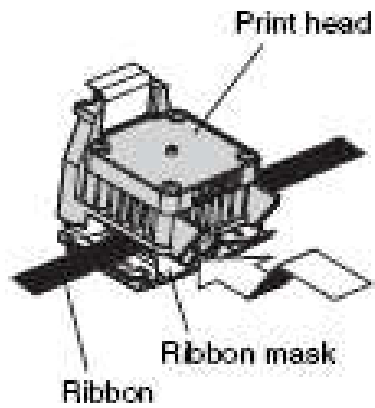

NOTICE: Install the cassette so that the ribbon is between the print head and the ribbon mask. Printing will not come out properly if the ribbon is placed behind the ribbon mask.

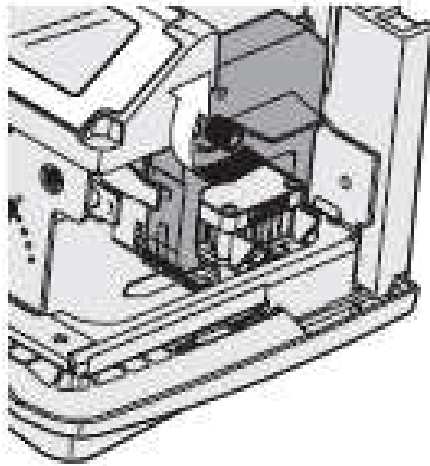

Step 5

Turn the knob of the cassette in the direction of the arrow to tighten the ribbon.

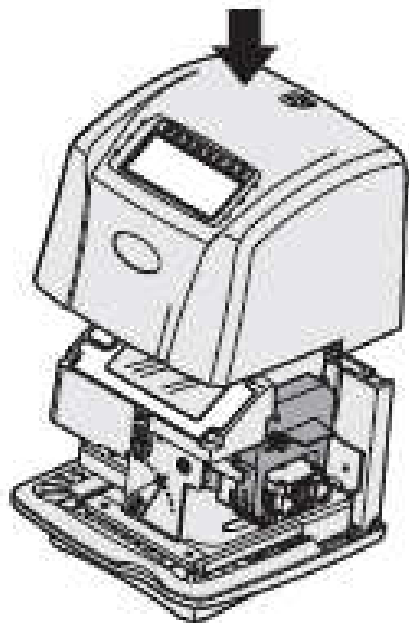

Step 6

Replace the cover, and then plug the AC adapter into the AC outlet.

RESETTING

To return all setting to the factory defaults, push the reset switch with a pointed implement.

NOTICE: All your custom settings will be deleted and will revert to the factory defaults when the reset switch is pushed. To make new settings, please refer to "SETTING".

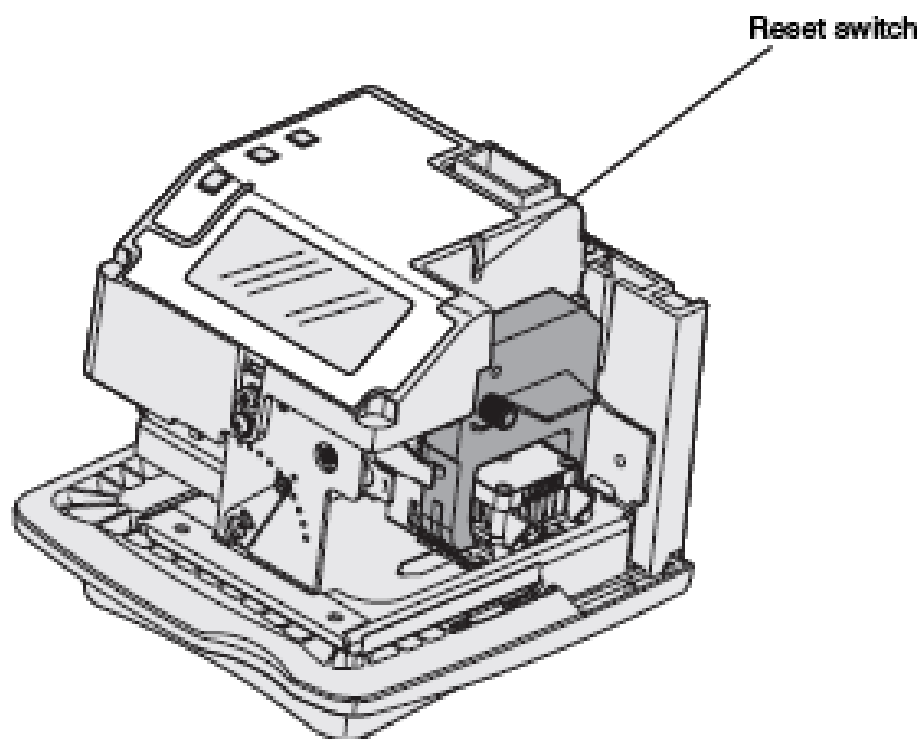

SPECIFICATIONS

Clock accuracy	Monthly accuracy ± 1.5 sec. (at ordinary temperatures)
Calendar	Year up to 2099. Automatically adjusted to leap years, 31-day months and months with thirty or fewer days, and the days of the week.
Printing system	Dot matrix imprint
Power failure compensation	Three years of cumulative power failure hours after the date of shipment.
Operating environment:	Temperature: +25° to 113°F (-5° to 45°C) Humidity: 20 to 80%, no condensation The unit operates normally at temperatures of 5°C or below, but the print density, reaction of the liquid crystal display, and the number of prints at power failure are inferior to those at normal temperature operation.
Dimension	5.35"(w) x 4.85"(h) x 6.00"(d) (136(w) x 123(h) x 152(d) mm)
Weight	Approx. 2 POUNDS (1.0 kg)
Power consumption	0.01A (standby) / 0.45A (printing), AC 120V 60Hz
Rating of AC adapter	I/P AC 100-120V 50-60Hz 0.45A, O/P DC 12V 1.5A (displayed)

NOTICE: Use only the supplied AC adapter.

Limited One-Year Warranty

Lathem warrants the hardware products described in this guide against defects in material and workmanship for a period of one year from date of original purchase from Lathem or from an authorized Lathem reseller. The conditions of this warranty and the extent of the responsibility of Lathem Time Corporation ("Lathem") under this warranty are listed below.

1. This warranty will become void when service performed by anyone other than an approved Lathem warranty service dealer results in damage to the product.
2. This warranty does not apply to any product which has been subject to abuse, neglect, or accident, or which has had the serial number altered or removed, or which has been connected, installed, adjusted, or repaired other than in accordance with instructions furnished by Lathem.
3. This warranty does not cover dealer labor cost for removing and reinstalling the machine for repair, or any expendable parts that are readily replaced due to normal use.
4. The sole responsibility of Lathem under this warranty shall be limited to repair of this product, or replacement thereof, at the sole discretion of Lathem.
5. If it becomes necessary to send the product or any defective part to Lathem or any authorized service dealer, the product must be shipped in its original carton or equivalent, fully insured with shipping charges prepaid. Lathem will not assume any responsibility for any loss or damage incurred in shipping.
6. **WARRANTY DISCLAIMER AND LIMITATION OF LIABILITY:** Except only the limited express warranty set forth above, the products are sold with no expressed or implied warranties of any kind, and the implied warranties of merchantability and fitness for a particular purpose are hereby expressly disclaimed. No warranties are given with respect to products purchased other than from Lathem or an authorized Lathem reseller and any such products are purchased "as is, with all faults." In no event will Lathem be liable for any direct, indirect, special, incidental or consequential damages arising out of or in connection with the delivery, use or inability to use, or performance of this product. In the event any limited remedy given herein shall be deemed to have failed of its essential purpose, Lathem's maximum liability shall be to refund the purchase price upon return of the product.
7. Proof of date of purchase from Lathem or an authorized Lathem reseller is required for warranty service on this product.
8. This Warranty grants specific legal rights. Additional legal rights, which may vary by locale, may also apply.
9. Should any difficulties arise with the performance of this product during warranty, or with any Lathem authorized service centers, contact Lathem Time.

Lathem Time Corp.

TIME CARDS

HOW TO PROGRAM THE CLOCK

To enter the program setting mode, you should plug the AC adapter into the AC outlet and remove the cover. Thereafter press the **SELECT** button once. Then the clock goes into the program mode showing the "▲" on the display positioned at the "TIME".

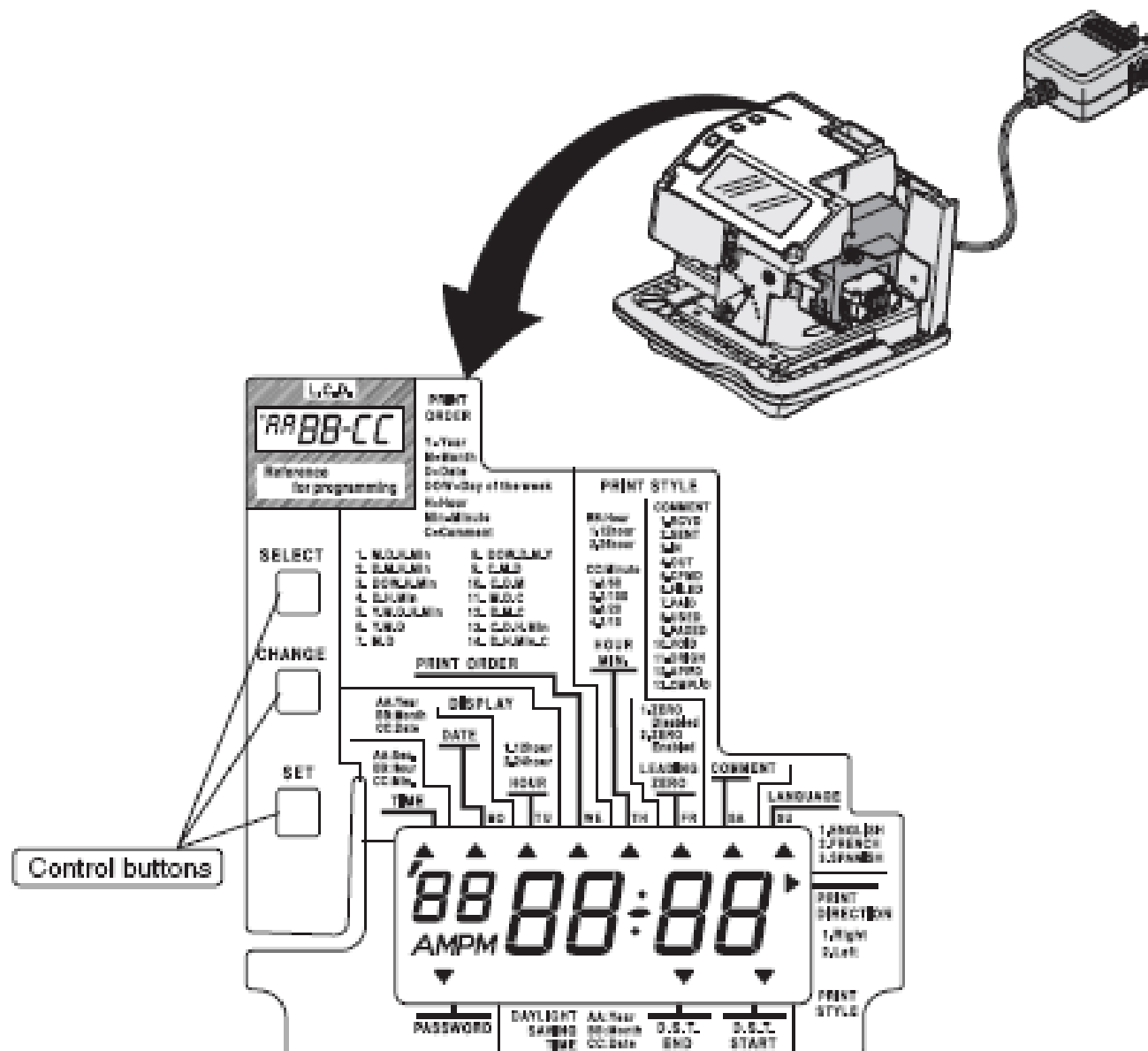

Function of 3 control buttons

SELECT: You can select the desired program setting mode by pressing this **SELECT** button. Selected program setting mode is indicated by the "▲" mark on the display.

CHANGE: When you press the **CHANGE** button, you can increment the set value.

SET: You can set the value selected on the display by pressing the **SET** button. Thereafter you press this **SET** button again, you can return the clock to the normal operation mode.

SETTING THE DISPLAY FORMAT

SETTING THE TIME

Example: Change the time from 10:08 to 10:09.

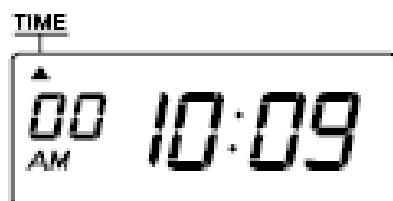
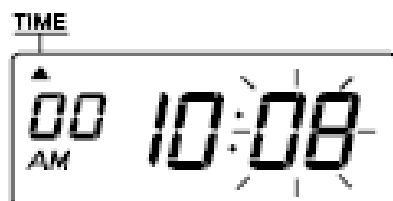
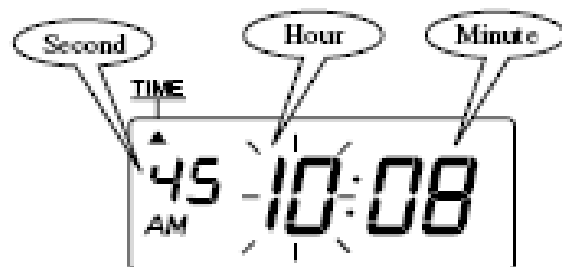

Step 1

Press the **SELECT** button and position the "▲" mark at the "TIME".

At that moment, the "Hour" flashes. (The flashing means it can be changed.)

Change the "Hour".

In case of the example, press the **SET** button because the hour is not to be changed.

At that moment, the flashing changes from "Hour" to "Minute".

Step 2

Change the "Minute".

Press the **CHANGE** button to set at "09", and then press the **SET** button.

At that moment, the "Second" starts to run from "00".

Step 3

After you finish setting the time, press the **SET** button once again.

Now the time setting has been completed. Replace the cover.

IMPORTANT: If you do not complete Step 3, the clock will not print.

SETTING THE DATE

Example: Change the date from October 20, 2008 to October 21, 2008.

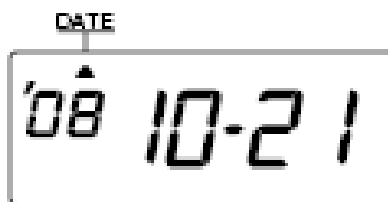
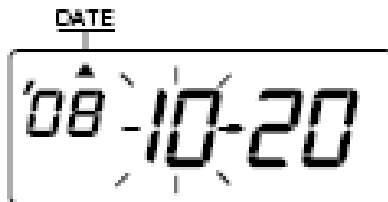
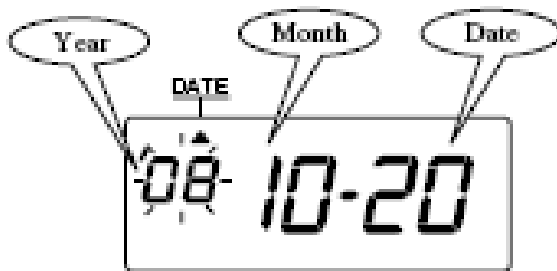

Step 1

Press the **SELECT** button and position the "▲" mark at the "DATE".
At that moment, the "Year" flashes. (The flashing means it can be changed.)

Change the "Year".

In case of the example, press the **SET** button because the year 2008 is not to be changed.

At that moment, the flashing changes from "Year" to "Month".

Step 2

Change the "Month".

In case of the example, press the **SET** button because the month is not to be changed.

At that moment, the flashing changes from "Month" to "Date".

Step 3

Change the "Date".

Press the **CHANGE** button to set at "21", and then press the **SET** button.

Step 4

After you finish setting the date, press the **SET** button once again.

Now the date setting has been completed. Replace the cover.

IMPORTANT: If you do not complete Step 4, the clock will not print.

SETTING THE 12/24 HOUR

Example: Change the hour format to 24 hour.

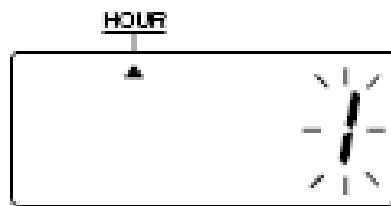

Step 1

Press the **SELECT** button and position the "▲" mark at the "HOUR".

At that moment, the flashing digit indicates "Order Options" of the hour format. (The flashing means it can be changed.)

	Order Options	Display
1.	12 hour	PM 3:00
2.	24 hour	15:00

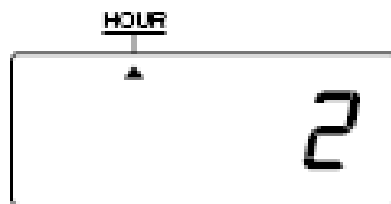

In case of the example, press the **CHANGE** button to set at "2". And then press the **SET** button.



Step 2

After you finish setting the 12/ 24 hour, press the **SET** button once again.

Now the 12/24 hour setting has been completed. Replace the cover.

IMPORTANT: If you do not complete Step 2, the clock will not print.

SETTING THE PRINT ORDER

Example: Change the print order to "Day of the week, Hour, Minute".

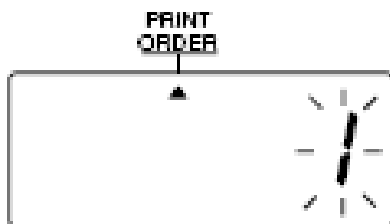

Step 1

Press the **SELECT** button and position the "▲" mark at the "PRINT ORDER".

At that moment, the flashing digits indicate "Order Options" of the print order. (The flashing means it can be changed.)

Y=Year, M=Month, D=Date, DOW=Day of the week, H=Hour, Min=Minute
C=Comment

	Order Option	Print Example
1.	M.D.H.Min	JA 10:00 AM
2.	D.M.H.Min	10 JA 10:00 AM
3.	DOW.H.Min	TH 10:00 AM
4.	D.H.Min	10:00 AM
5.	Y.M.D.H.Min	'08 JA 10:00 A (Small Font)
6.	Y.M.D	'08 JA
7.	M.D	JA
8.	DOW.D.M.Y	TH 10 JA '08
9.	C.M.D	SENT JA
10.	C.D.M	SENT 10 JA
11.	M.D.C	JA 10 SENT
12.	D.M.C	10 JA SENT
13.	C.D.H.Min	SENT 10:00 A (Small Font)
14.	D.H.Min.C	10:00 A SENT (Small Font)

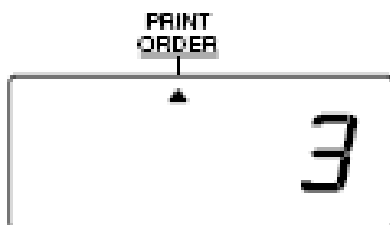

In case of the example, press the **CHANGE** button to set at "3". And then press the **SET** button.

Step 2

After you finish setting the print order, press the **SET** button once again.

Now the print order setting has been completed. Replace the cover.



IMPORTANT: If you do not complete Step 2, the clock will not print.

SETTING THE PRINT STYLE

SETTING THE HOUR/MIN.

Example: Change the print style of the "Hour" and "Minute" to 24 hour and 1/100 min.

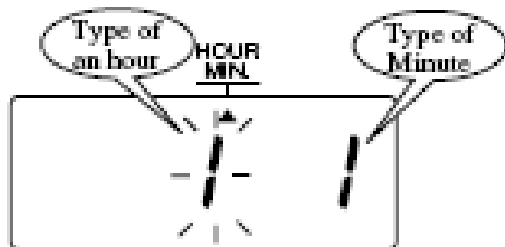

Step 1

Press the **SELECT** button and position the "▲" mark at the "HOUR /MIN".

At that moment, the flashing digit at the left indicates "Order Options" of the print style of the "Hour". (The flashing means it can be changed.)

Change the "Hour".

	Order Options	Print Example
1.	12 Hour	JA ☞ 3:00 PM
2.	24 Hour	JA ☞ 15:00

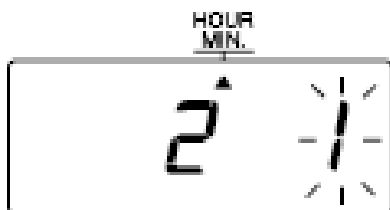

In case of the example, press the **CHANGE** button to set at "2". And then press the **SET** button.

At that moment, the flashing changes from "Hour" to "Minute".

Step 2

Change the "Minute".

	Order Options	Print Example		Order Options	Print Example
1.	1/60 Min.	JA ☞ 12:10 AM	3.	1/20 Min. (=5/100 Min.)	JA ☞ 12.15 AM
2.	1/100 Min.	JA ☞ 12.17 AM	4.	1/10 Min.	JA ☞ 12.1AM



In case of the example, press the **CHANGE** button to set at "2". And then press the **SET** button.

Step 3

After you finish setting the hour/minute, press the **SET** button once again.

Now the hour/minute setting has been completed. Replace the cover.



IMPORTANT: If you do not complete Step 3, the clock will not print.

SETTING THE LEADING ZERO

Example: Change the leading zero to "ZERO: Disabled".

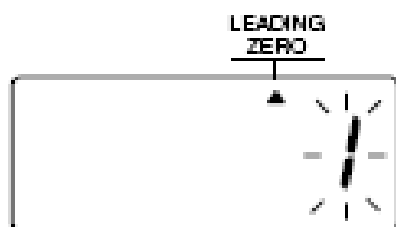

Step 1

Press the **SELECT** button and position the "▲" mark at the "LEADING ZERO". At that moment, the flashing digit indicates "Order Options" of the leading zero.

(The flashing means it can be changed.)

	Order Options	Print Example
1.	ZERO Disabled	JA $\overline{00}$ 3:00 PM
2.	ZERO Enabled	JA $\overline{00}$ 03:00 PM

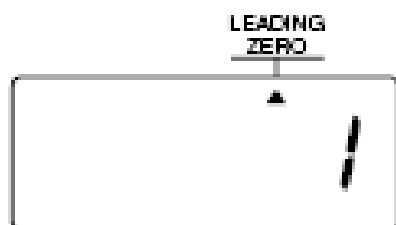

In case of the example, press the **CHANGE** button to set at "1". And then press the **SET** button.



Step 2

After you finish setting the leading zero, press the **SET** button once again. Now the leading zero setting has been completed. Replace the cover.

IMPORTANT: If you do not complete Step 2, the clock will not print.

SETTING THE COMMENT

Example: Change the comment to "SENT".



Step 1

Press the **SELECT** button and position the "▲" mark at the "COMMENT".
 At that moment, the flashing digits indicate "Order Options" of the comment.
 (The flashing means it can be changed.)

	Order Options	Print Example
1.	RCVD (Received)	JA 01 RCVD
2.	SENT	JA 01 SENT
3.	IN	JA 01 IN
4.	OUT	JA 01 OUT
5.	CFMD (Confirmed)	JA 01 CFMD
6.	FILED	JA 01 FILED
7.	PAID	JA 01 PAID
8.	USED	JA 01 USED
9.	FAXED	JA 01 FAXED
10.	VOID	JA 01 VOID
11.	ORIGN (Original)	JA 01 ORIGN
12.	APRD (Approved)	JA 01 APRD
13.	CMPLD (Completed)	JA 01 CMPLD

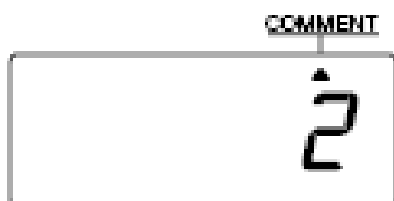

In case of the example, press the **CHANGE** button to set at "2". And then press the **SET** button.



Step 2

After you finish setting the comment, press the **SET** button once again.
 Now the comment setting has been completed. Replace the cover.

IMPORTANT: If you do not complete Step 2, the clock will not print.

SETTING THE LANGUAGE

This setting is available if you select "Month," "Day of the week" or "Comment" in previous "PRINT ORDER".

Example: Change the print language into French.

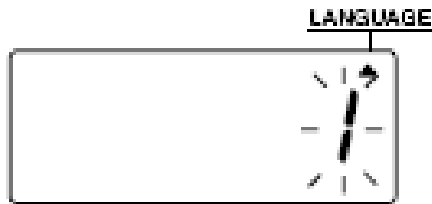

Step 1

Press the **SELECT** button and position the "▲" mark at the "LANGUAGE".

At that moment, the flashing digit indicates "Order Options" of the print language. (The flashing means it can be changed.)

	Order Options	Print Example
1.	ENGLISH	WE, 3 DE '08 OUT 3 10:00A
2.	FRENCH	ME, 3 DE '08 SORT 3 10:00A
3.	SPANISH	MI, 3 DC '08 SAL 3 10:00A

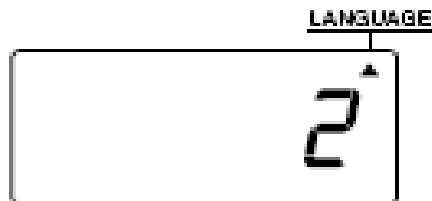

In case of the example, press the **CHANGE** button to set at "2". And then press the **SET** button.

Step 2

After you finish setting the language, press the **SET** button once again.

Now the language setting has been completed. Replace the cover.



IMPORTANT: If you do not complete Step 2, the clock will not print.

SETTING THE PRINT DIRECTION

Example: Change the print direction to "Left".

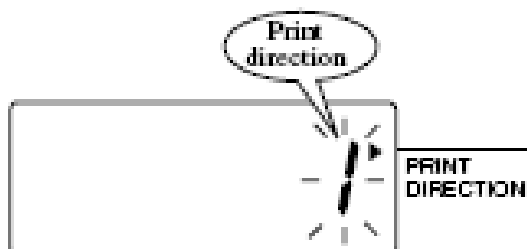

Step 1

Press the **SELECT** button and position the "▲" mark at the "PRINT DIRECTION". At that moment, the flashing digit at the left indicates "Order Options" of the print direction. (The flashing means it can be changed.)

Change the "Print Direction".

	Order Options
1.	Right - Prints on right edge of card.
2.	Left - Prints on left edge of card.



In case of the example, press the **CHANGE** button to set at "2". And then press the **SET** button.



Step 2

After you finish setting the print direction, press the **SET** button once again. Now the print direction setting has been completed. Replace the cover.

IMPORTANT: If you do not complete Step 2, the clock will not print.

SETTING THE DAYLIGHT SAVING TIME

Automatic DST correction (recommended)

By default, the daylight saving time is already set to start on the second Sunday of March and to end on the first Sunday of November. However, if you once disabled this function and want to set it again or change starting and/or ending date, please change dates as follows.

Once you reset the unit, setting of daylight saving time will return to the default value.

Example: Start date Sunday, March 9, 2008.

End date Sunday, November 2, 2008.

If you set as the above, the time clock remembers the start date as the second Sunday of March and the end date as the first Sunday of November. Once set, the time clock automatically updates the settings every year thereafter. No further manual setting is necessary.

SETTING THE STARTING DATE OF DAYLIGHT SAVING TIME

Example: Daylight saving time starts on Sunday, March 9, 2008.

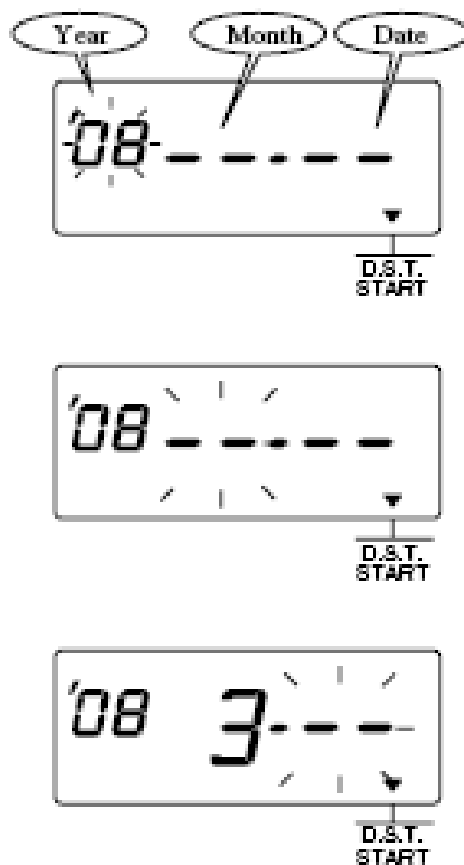

Step 1

Press the **SELECT** button and position the "▲" mark at the "D.S.T. START". At that moment, the "Year" flashes. (The flashing means it can be changed.)

Change the "Year".

In the case of the example, press the **SET** button because the year 2008 is not to be changed.

At that moment, the flashing changes from "Year" to "Month".

Step 2

Change the "Month".

Press the **CHANGE** button to set at "3". And then press the **SET** button.

At that moment, the flashing changes from "Month" to "Date".

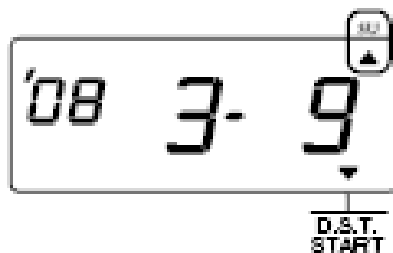

Step 3

Change the "Date".
 Press the **CHANGE** button to set at "9".
 And then press the **SET** button.

Step 4

After you finish setting the starting date of D.S.T., press the **SET** button once again.
 Now the starting date of D.S.T. setting has been completed.
 Go on to the "SETTING THE ENDING DATE OF DAYLIGHT SAVING TIME".

SETTING THE ENDING DATE OF DAYLIGHT SAVING TIME

Example: Daylight saving time ends on Sunday, November 2, 2008.

The setting procedure is the same as that for the starting date of D.S.T..

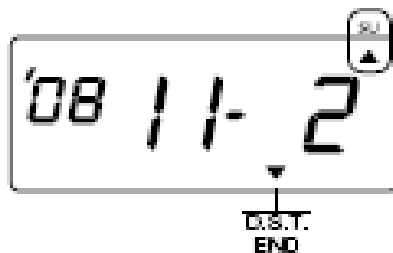
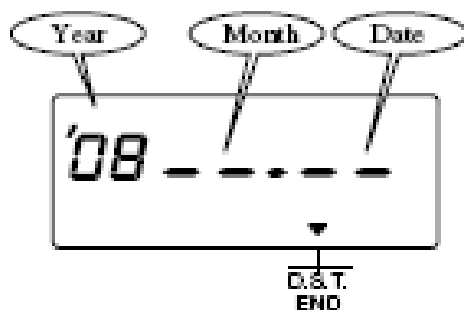

Step 1

Press the **SELECT** button and position the "▲" mark at the "D.S.T. END".

Step 2

Set the ending year, month, and date of daylight saving time in the same way as for the starting date of D.S.T..

Step 3

After you finish setting the ending date of D.S.T., press the **SET** button once again.
 Now the ending date of D.S.T. setting has been completed. Replace the cover.

IMPORTANT: If you do not complete Step 3, the clock will not print.

DELETING THE DAYLIGHT SAVING TIME SETTING

To delete and cancel the daylight saving time setting, change the display of "Month" of the starting setting to " - - -".

Example: Change March 9, 2008 of "D.S.T. START" and delete daylight saving time setting.

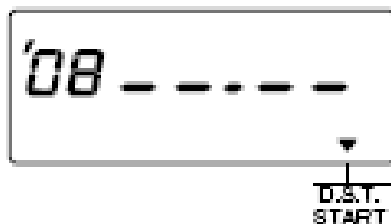
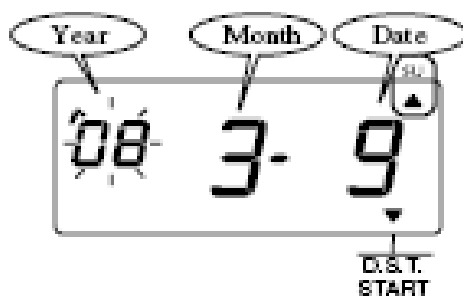

Step 1

Press the **SELECT** button and position the "▲" mark at the "D.S.T. START".

Next, press the **SET** button.

Step 2

Change "Month" to " - - -" and press the **SET** button twice to change the display as shown in the left figure. This cancels the day light saving time settings.

Step 3

Press the **SET** button once again. Now the D.S.T. deleting has been completed. Replace the cover.

IMPORTANT: If you do not complete Step 3, the clock will not print.

SETTING THE PASSWORD

When the password is set, you are asked to enter it. If the password you entered does not coincide with the setting, you cannot change the setting values.

You may set a password by any 4-digit number from 0001 to 9998.

Note a number "0000" and "9999" cannot be used as a password.

REGISTERING THE PASSWORD

Example: Set the password "1234".



PASSWORD

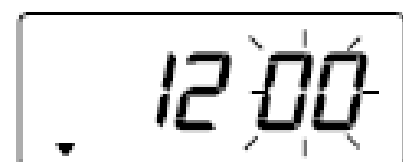

PASSWORD

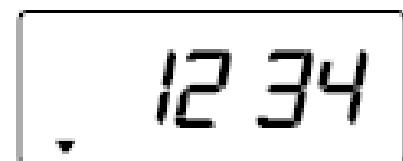

PASSWORD

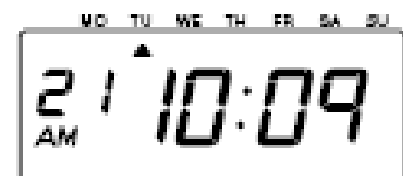

Step 1

Press the **SELECT** button and position the "▲" mark at the "PASSWORD".

At that moment, first two digits flash. (The flashing means it can be changed.)

In case of the example, press the **CHANGE** button to set at "12". And then press the **SET** button.

At that moment, the flashing changes to last two digits.

Step 2

In case of the example, press the **CHANGE** button to set at "34". And then press the **SET** button.

Step 3

After you finish registering the password, press the **SET** button once again.

Now the password registering has been completed. Replace the cover.

IMPORTANT: If you do not complete Step 3, the clock will not print.

HOW TO CHANGE SETTING WHEN THE PASSWORD IS SET

Once the password is set, you have to enter the password for changing any setting. "99 99" will be displayed when you press the **SELECT** button before entering.

Example: Password "1234".

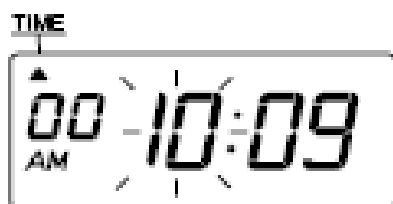
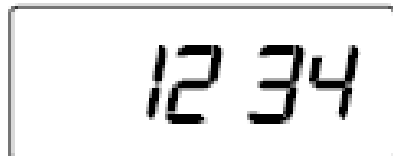
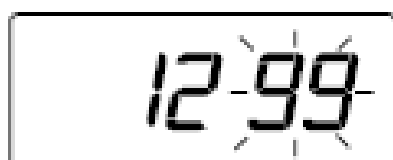

Step 1

Press the **SELECT** button, at that moment "99 99" is displayed and first two digits flashes. (The flashing means it can be changed.)

In the example, press the **CHANGE** button to set at "12". And then press the **SET** button.

At that moment, the flashing changes to last two digits.

Step 2

In case of the example, press the **CHANGE** button to set at "34". And then press the **SET** button.

At that moment, the '▲' mark indicates the "TIME".

Step 3

Select desired setting mode by pressing the **SELECT** button.

Then make settings as explained.

CANCELING THE PASSWORD

The code '00 00' must be entered to cancel the password.

Example: Cancel the password "1234".

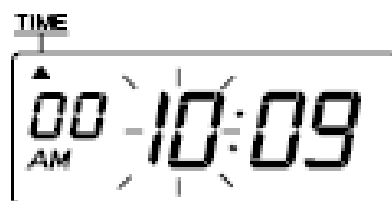

PASSWORD



PASSWORD

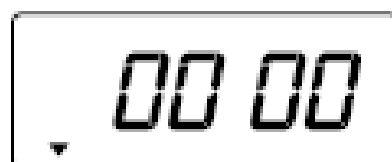

PASSWORD

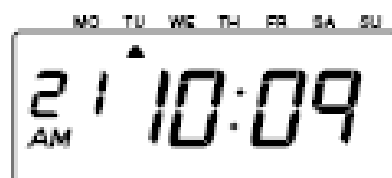

Step 1

Enter the password in the same way as for the previous page.

At that moment, the "▲" mark indicates the "TIME".

Step 2

Press the **SELECT** button and position the "▲" mark at the "PASSWORD".

At that moment, first two digits '12' flashes. (The flashing means it can be changed.)

Press the **CHANGE** button to set at "00". And then press the **SET** button.

At that moment, the flashing changes to last two digits "34".

Step 3

Press the **CHANGE** button to set at "00". And then press the **SET** button.

Step 4

After you finish canceling the password, press the **SET** button once again.

Now the password canceling has been completed. Replace the cover.

IMPORTANT: If you do not complete Step 4, the clock will not print.