



SP-250

USER MANUAL









PRECAUTIONS







This User Guide will teach you how to safely and properly operate the SP-250™ Electronic Time and Date Stamp. Please follow all instructions to avoid possible damage to yourself, others, or the machine.

Symbols

The symbols you will see throughout this guide indicate various warnings and cautions. To ensure your safety and proper operation of the machine, please review the following explanations.

 Warning	Improper handling may cause bodily accidents, including serious injury or death.
 Caution	Improper handling may harm individuals or materials.

 Improper handling may cause electric shock DANGER.	 "Must do" sign.
 Do not disassemble this machine.	 Remove the line cord plug from the outlet.
 "Do not" sign.	

 Warning	
	Do not disassemble this machine: The inside is high-voltage, and disassembly may lead to electric shock.
	Do not modify this machine. Modifications may cause fire and/or electrical shock.
	Unplug the machine immediately and contact your dealer for service if irregularities, such as heat or smoke generation, or odor emission occur. Further use may cause a fire or electrical shock.
	Do not use any voltage of the power source other than that which is designated. Do not share a single outlet with another plug, which may lead to fire or shock hazard.
	Do not damage, break, or modify the power cord. Do not pull, forcefully bend, or place a heavy object on the cord. Any of these may damage the cord, resulting in potential fire or electric shock.



Disconnect the plug from the outlet immediately and contact your dealer for service if foreign matter including metal, water, or any other liquid enters the machine. Further use may result in fire or electric shock.



Do not plug or unplug the machine with a wet hand, which may result in electric shock.



Caution



Do not place the machine on an uneven or tilted surface, which may cause the machine to drop or fall resulting in injuries.



Do not place water-filled containers or metal objects on top of machine; Spilled water or metallic object slipping inside the machine may cause a fire or shock hazard.



Do not install the machine in a humid or dusty environment, which may cause fire or electric shock.



Do not place the machine near a kitchen counter or humidifier. The oil, smoke, or steam in these areas may present a fire or shock hazard.



Do not yank the power cord plug from the outlet, which may damage the cord and lead to potential fire or electric shock.



Remove the line cord plug from the outlet before transferring the machine. Failure to do so may damage the cord and lead to potential fire or electric shock.



Do not touch the printer head, which may cause burns.



Insert the power plug as far as it will go. Improper plug insertion may lead to fire or shock hazard.



Do not insert or drop any time card other than that which is specified into the slot. Such misuse may cause fire or electrical shock.



If the machine is dropped or the case is broken, contact your dealer immediately for service: Further use may lead to fire or shock hazard.

Daily Care

Turn off the power and use a dry cloth to wipe the case clean of dust and dirt.

Contents

The Basics

What's in the Box.....	1
Time Stamp at a Glance.....	1
Initialize the Clock.....	1
Set up the Clock.....	2
3.1 Set the Time.....	3
3.2 Set the Date.....	3
3.3 Set the Print Order.....	3

Advanced Features

4.1 Set 12/24 Hour Format.....	4
4.2 Set the Print Pattern.....	5
4.3 Set the Pre-programmed Comments.....	6
4.4 Set the Language.....	7
4.5 Set the Print Method.....	8
4.6 Set the Daylight Savings Time (D.S.T.).....	9-10
4.7 Set the Number Digits.....	11
4.8 Set the Initial Number	12
4.9 Set the Time Table Program	13-14
4.10 Set the Customized Comments	15-16
How to Correct Customized Comments.....	17
Reset.....	17
Replace the Ribbon Cassette.....	18
Install the Optional NiCad Battery.....	19
Troubleshooting.....	20
Alphanumeric Character Code.....	21
Large Characters.....	22
Small Characters.....	23
Language-specific Characters.....	24
Cautions.....	25
Specifications.....	25

What's In Box

User Guide



Two keys



One ribbon cassette



SP-250 at a Glance

<Front view>

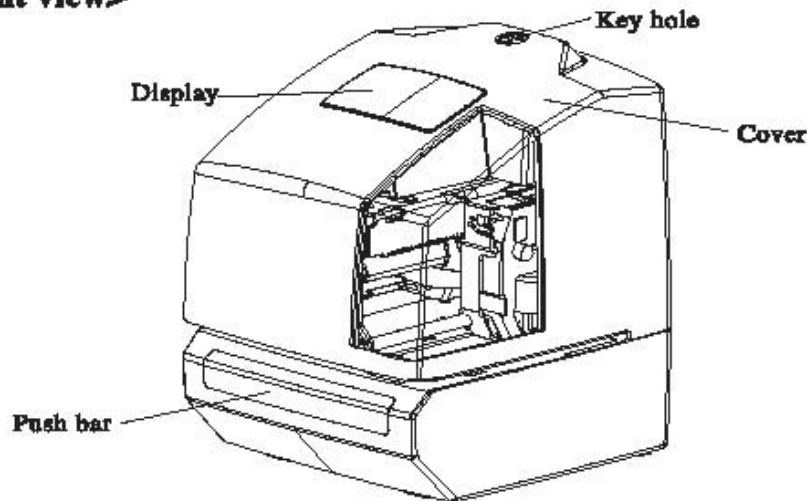

<Back view>

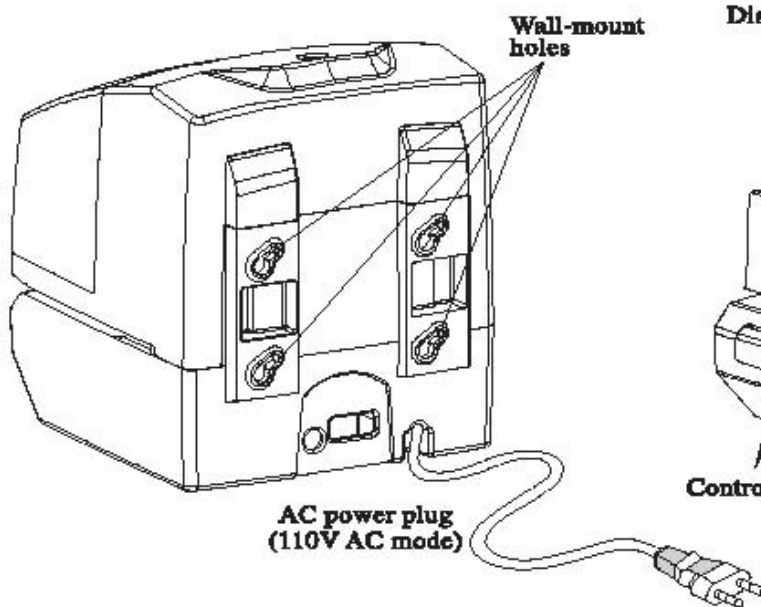

<Cover off>

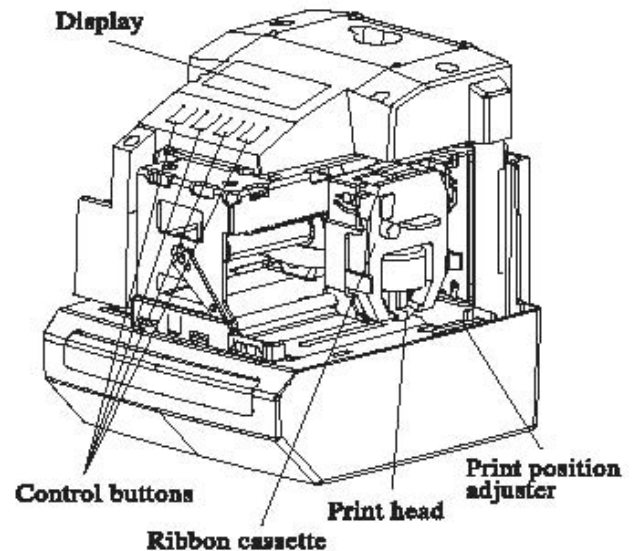

Initialize the Clock

Before you begin this procedure, run a timecard through the SP-250 to test the punch position. To adjust the location of the print position from the card edge, press and slide the print position adjuster, located on the bottom of the machine.

Set up the Clock

Here is a quick look at the function keys you'll use:

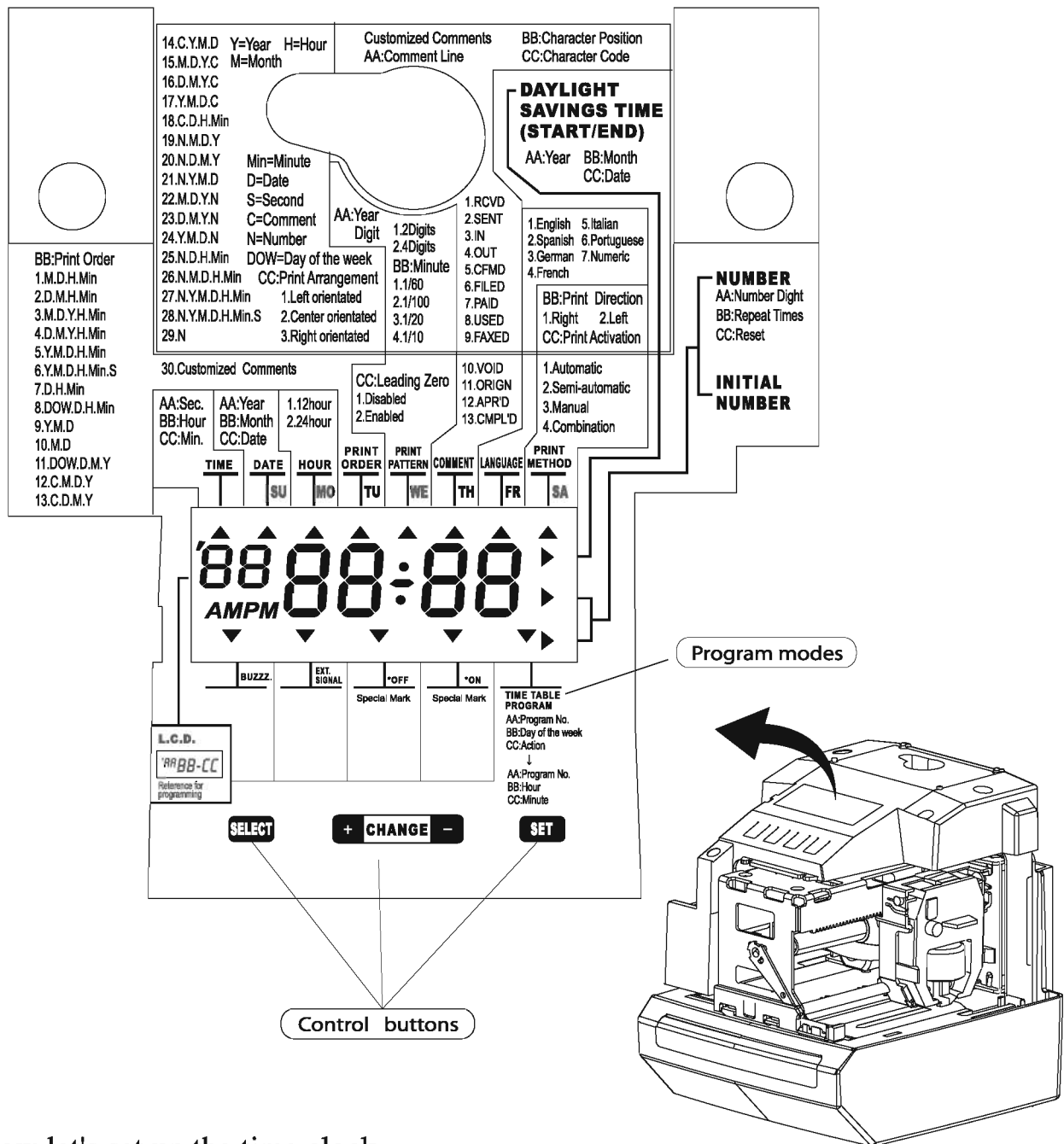

Now let's set up the time clock.

1. Press the **SELECT** button repeatedly to choose the desired program mode.
2. Press the **+ CHANGE** button to increase the setting value.
3. Press the **CHANGE -** button to decrease the setting value.
4. Press the **SET** button to confirm. Pressing this button again will revert Time Stamp to the normal operation mode.
5. Press the **SELECT** button once to enter the program setting mode. Time Stamp will now go into the program mode showing the ▲ on the display labeled "TIME" mark.

3.1 Set the Time

1. Press the [SELECT] button repeatedly until the ▲ corresponds to the "TIME" on the setting panel.
2. Use the [+] [-] buttons to adjust the hour and minute.
3. Press [SET] to confirm.
4. When finished, press [SET] again.

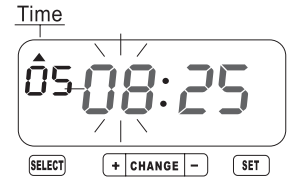

3.2 Set the Date

1. Press the [SELECT] button repeatedly until the ▲ corresponds to the "DATE" on the setting panel.
2. Use the [+] [-] buttons to adjust the current year; Press [SET] to confirm.
3. Use the [+] [-] button to adjust month and date, Press [SET] to confirm.
4. When finished, press [SET] again.

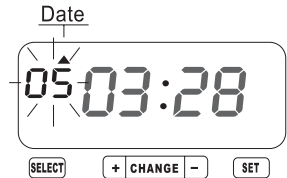

3.3 Set the Print Order

1. Press the [SELECT] button repeatedly, until the ▲ corresponds to the "PRINT ORDER" on the setting panel.
2. Use the [+] [-] buttons to choose the number corresponding to the suitable print order on the setting panel.
3. Press [SET] to confirm.
4. When finished, press [SET] again.

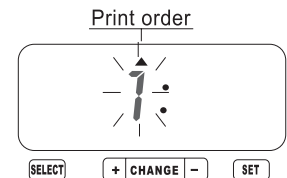

Y=Year, M=Month, D=Date, DOW=Day of the week, H=Hour, Min=Minute, S=Second
C=Comment, N=Number

	Print Order Options	Print Example		Print Order Options	Print Example
1.	M.D.H.Min	JAN 31 10:00	16.	D.M.Y.C	31 JAN '06 SENT
2.	D.M.H.Min	31 JAN 10:00	17.	Y.M.D.C	'06 JAN 31 SENT
2.	M.D.YH.Min	JAN 31 '06 10:00	18.	C.D.H.Min	SENT 31 10:00
4.	D.M.Y.H.Min	31 JAN '06 10:00	19.	N.M.D.Y	000123 JAN 31 '06
5.	Y.M.D.H.Min	'06 JAN 31 10:00	20.	N.D.M.Y	000123 31 JAN '06
6.	Y.M.D.H.Min.S	'06 JAN 31 10:00:00	21.	N.Y.M.D	000123 '06 JAN 31
7.	D.H.Min	31 10:00	22.	M.D.Y.N	JAN 31 '06 000123
8.	DOW.D.H.Min	FR, 31 10:00	23.	D.M.Y.N	31 JAN '06 000123
9.	Y.M.D	'06 JAN 31	24.	Y.M.D.N	'06 JAN 31 000123
10.	M.D	JAN 31	25.	N.D.H.Min	000123 31 10:00
11.	DOW.D.M.Y	FR, 31 JAN '06	26.	N.M.D.H.Min	123 JAN 31 10:00
12.	C.M.D.Y	SENT JAN 31 '06	27.	N.Y.M.D.H.Min	123 '06 JAN 31 10:00
13.	C.D.M.Y	SENT 31 JAN '06	28.	N.Y.M.D.H.Min.S	123 '06 JAN 31 10:00:00
14.	C.Y.M.D	SENT '06 JAN 31	29.	N	000123
15.	M.D.Y.C	JAN 31 '06 SENT	30.	Customized Comments	(Ref. P.15)

Advanced Features

4.1 Set the 12/24 Hour Format

1. Press the [SELECT] button repeatedly until the ▲ corresponds to the "HOUR" on the setting panel.
2. Use the [+][−] buttons to select the number "1" for 12-hour mode, or "2" for 24-hour mode.



	Hour Format Options	Display
1.	12 hour	PM 3:00
2.	24 hour	15:00

3. Press [SET] to confirm.
4. When finished, press [SET] again.

4.2 Set the Print Pattern

1. Press the [SELECT] button repeatedly, until the ▲ corresponds to the "PRINT PATTERN" on the setting panel.
2. Use the [+][−] buttons to choose "Year Digit Options."

	Year Digit Options	Print Example
1.	2 Digits	JAN 31 '06 10:00
2.	4 Digits	JAN 31 2006 10:00

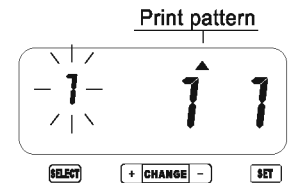

3. Press [SET] to confirm.
4. Use the [+][−] buttons to choose "Type of Minute."

	Type of Minute	Print Example
1.	1/60 Min.	JAN 31 2006 10:10
2.	1/100	JAN 31 2006 10.17
3.	1/20 Min.(=5/100 Min.)	JAN 31 2006 10.15
4.	1/10 Min.	JAN 31 2006 10.1

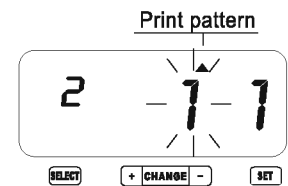

5. Use the [+][−] buttons to choose "Leading Zero."

	Leading Zero	Print Example
1.	ZERO disabled	JAN 1 3:00
2.	ZERO enabled	JAN 01 03:00

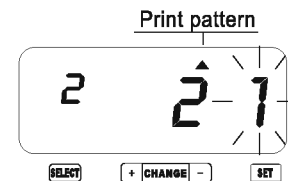

6. Press [SET] to confirm.
7. When finished, press [SET] again.

4.3 Set the Pre-programmed Comments

1. Press the [SELECT] button repeatedly, until the ▲ corresponds to the "COMMENT" on the setting panel.
2. Use the [+][−] buttons to choose your comment options.



	Comment Options	Print Example
1.	RCVD (Received)	JAN 31 '06 RCVD
2.	SENT	JAN 31 '06 SENT
3.	IN	JAN 31 '06 IN
4.	OUT	JAN 31 '06 OUT
5.	CFMD (Confirmed)	JAN 31 '06 CFMD
6.	FILED	JAN 31 '06 FILED
7.	PAID	JAN 31 '06 PAID
8.	USED	JAN 31 '06 USED
9.	FAXED	JAN 31 '06 FAXED
10.	VOID	JAN 31 '06 VOID
11.	ORIGN (Original)	JAN 31 '06 ORIGN
12.	APR'D (Approved)	JAN 31 '06 APR'D
13.	CMPL'D (Completed)	JAN 31 '06 CMPL'D

3. Press [SET] to confirm.
4. After you finish setting, press the [SET] button once again.

4.4 Set the Language

1. Press the [SELECT] button repeatedly, until the ▲ corresponds to the "LANGUAGE" on the setting panel.
2. Use the [+] [-] buttons to choose your printing language.

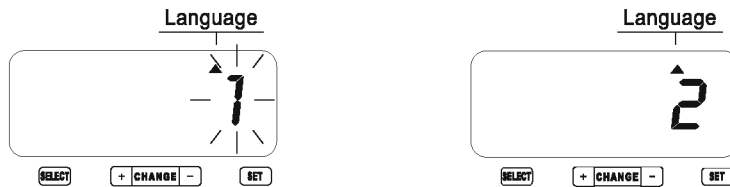

	Print Language Options	Print Example
1.	English	TH, 25 DEC '06 OUT 31 10:00
2.	Spanish	JU, 25 DIC '06 SAL 31 10:00
3.	German	DO, 25 DEZ '06 AUSG 31 10:00
4.	French	JE, 25 DEC '06 SORT 31 10:00
5.	Italian	GI, 25 DIC '06 USC 31 10:00
6	Portuguese	QI, 25 DEZ '06 SAIDA 31 10:00
7	Numeric	4, 25-12 '06 OUT 31 10:00

3. Press [SET] to confirm.
4. When finished, press [SET] again.

4.5 Set the Print Method

1. Press the [SELECT] button repeatedly, until the ▲ corresponds to the "PRINT METHOD" on the setting panel.
2. Use the [+] [-] buttons to select Print Direction.

	Print Direction Options
1.	Right
2.	Left

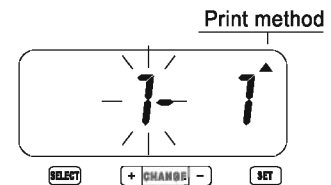

3. Press [SET] to confirm.
4. Use the [+] [-] buttons to choose the Print Activation mode.

	Print Activation Options
1.	Automatic
2.	Semi-automatic
3.	Manual
4.	Combination

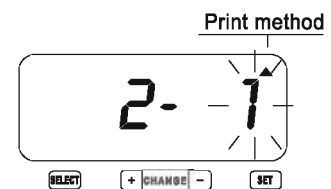

Print Activation options and what they mean:

- . Automatic - Simply insert a card or piece of paper into the machine to print.
 - . Semi-automatic - Press the push bar only when a card or piece of paper is inserted to print.
 - . Manual - Press the push bar to print.
 - . Combination - Print by either pressing the push bar or inserting a card or piece of paper.
5. Once you've selected the option you want, press [SET] to confirm.
 6. When finished, press [SET] again.

4.6 Set the Daylight Savings Time (D.S.T.)

D.S.T. Execution Time

This function allows you to set the clock to automatically adjust to Daylight Savings Time at 2:00 a.m., on the programmed date. (The clock will automatically *gain* one hour to show 3:00 a.m.)

At 3:00 a.m. on the last day of the Daylight Savings Time period, the clock will automatically *lose* one hour and return to 2:00 a.m.

First, enter D.S.T. Start Date

1. Press the [SELECT] button repeatedly, until the ▲ corresponds to the "DAYLIGHT SAVINGS TIME" on the setting panel.
2. Press the [+] [-] button to select the current year.
3. Press [SET] to confirm.
4. Use the [+] [-] buttons to select the D.S.T. beginning month.
5. Press [SET] to confirm.
6. Use the [+] [-] buttons to select the beginning date for D. S. T.
7. When finished [SET] again.

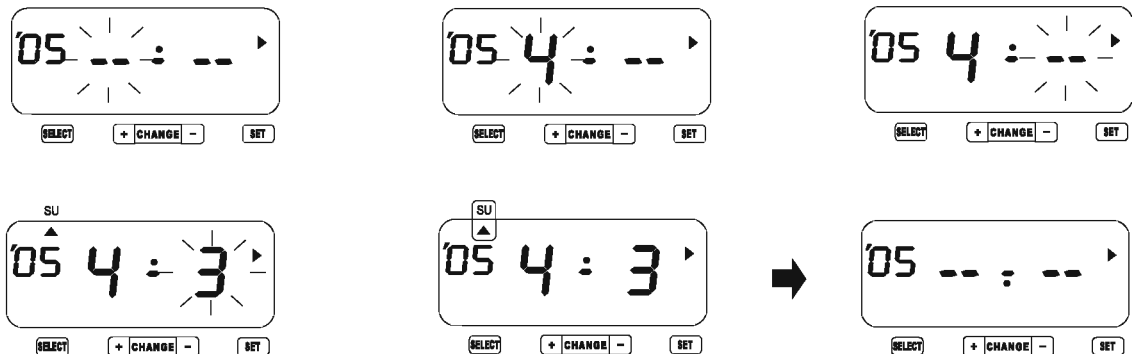
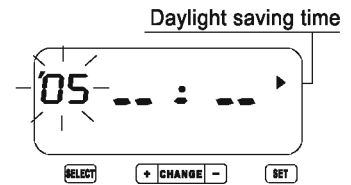

Now, set the D.S.T. End Date

8. Use the [+][−] buttons to select the D.S.T. ending year.
9. Press [SET] to confirm.
10. Use the [+][−] buttons to select the D.S.T ending month.
11. Press [SET] to confirm the setting value.
12. Use the [+][−] buttons to select the D.S.T ending date.
13. Press [SET] to confirm.
14. When finished, press [SET] again.

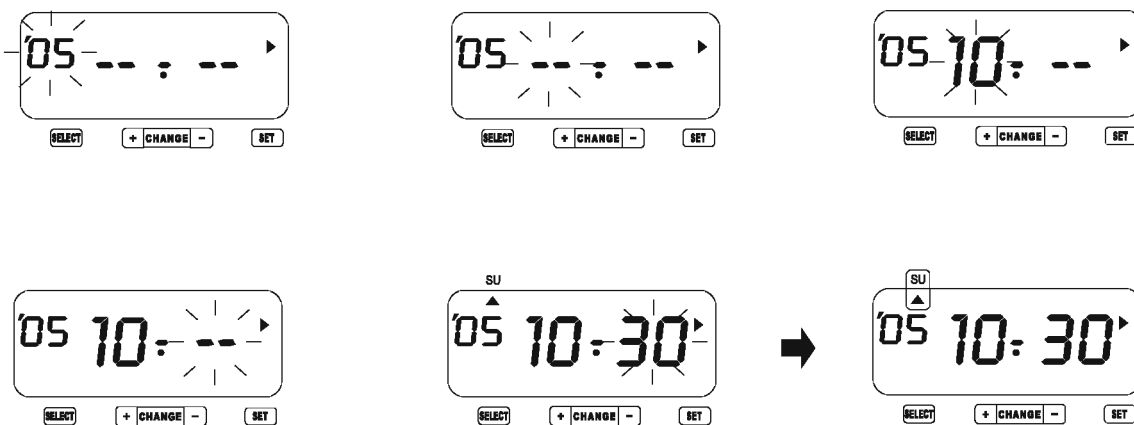

NOTE:

To delete/cancel Daylight Savings Time settings, change the "Month" display of the starting setting to "--".

4.7 Set the Number Digits

**You can set the Number Digits from 1 to 8.
Here's an example of how it will look in print:**

6 Digits of Number 123456 JAN 31 '06
4 Digits of Number 1234 JAN 31 '06

You can set the Repeat Times from 0 to 9. Print examples:

0 time repeat→ (1st time) 123456 JAN 31 '06
(2nd time) 123456 JAN 31 '06
(3rd time) 123456 JAN 31 '06
(4th time) 123456 JAN 31 '06
(5th time) 123456 JAN 31 '06
(Etc.)

2 time repeat→ (1st time) 123456 JAN 31 '06
(2nd time) 123456 JAN 31 '06
(3rd time) 123457 JAN 31 '06
(4th time) 123457 JAN 31 '06
(5th time) 123458 JAN 31 '06
(Etc.)

1. Press the [SELECT] button repeatedly, until the ▲ corresponds to the "NUMBER " on the setting panel.
2. Use the [+] [-] buttons to select how many digits you want for the printed number.
3. Press [SET] to confirm.
4. Use the [+] [-] buttons to select repeat times for print
5. Use the [SET] to confirm.
6. Use the [+] [-] buttons to select the Reset Options.
7. When finished, press [SET] again.

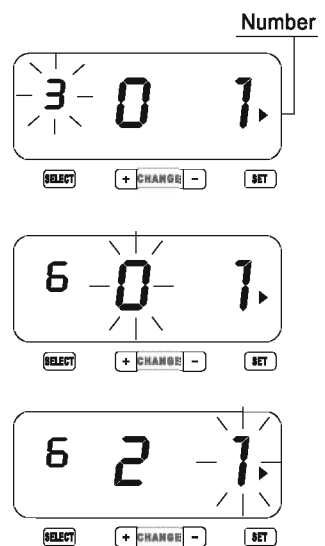

	Reset Options	Execution event of Reset.
1.	Disabled
2.	Return to INITIAL NUMBER	Change of date
3.	Return to 0	Change of date

4.8 Set the Initial Number

1. Press the [SELECT] button repeatedly, until the ▲ corresponds to the " INITIAL NUMBER " on the setting panel.
2. Use the [+] [-] buttons to select the number of the first digit.
3. Press [SET] to confirm.
4. Use the [+] [-] buttons to select the number of the second digit.
5. Press [SET] to confirm.
6. Repeat step 2-5 to complete the initial number setting.
7. Press [SET] to confirm.

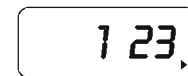
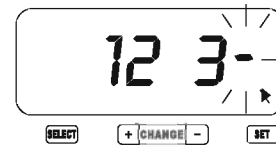
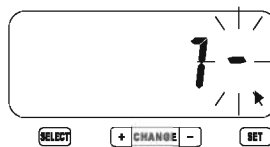
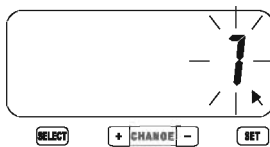
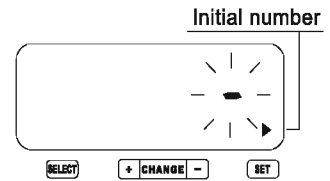

NOTE:

The number of digits (maximum eight) for "Initial Number," depends on the number set you selected in section "4.7 Set the Number."

8. When finished, press [SET] again.

4.9 Set the Time Table Program

The time table program function allows you to enable:

- . A special mark "*" when printing
- . An external time signal
- . A built-in buzzer

You can program these functions for each day of the week, and each pay period. Here's how.

1. Press the [SELECT] button repeatedly, until the ▲ corresponds to the "TIME TABLE PROGRAM" on the setting panel.

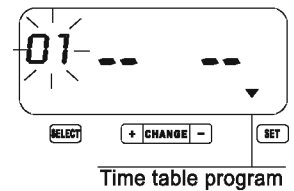

2. Press [SET] to enter your selection.
3. Use the [+][−] button to select the "Day of the Week."

	Day of the week		Day of the week
1.	Monday only	6.	Saturday only
2.	Tuesday only	7.	Sunday only
3.	Wednesday only	8.	Monday to Friday
4.	Thursday only	9.	Monday to Saturday
5.	Friday only	10.	Every day

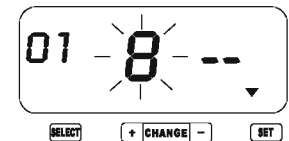

4. Press [SET] to confirm the date.
5. Use the [+][−] buttons to select the "Action" for that set.

	Action
1.	Special mark "*" on
2.	Special mark "*" off
3.	External signal on
4.	Built-in buzzer on



6. Press [SET] to confirm.

7. Use the [+][−] buttons to select the hours.
8. Press [SET] to confirm.
9. Use the [+][−] buttons to select the minute.
10. Press [SET] to confirm.
11. Use the [+][−] buttons to select the second.
12. Press [SET] to confirm.
13. Use the [+] button, enter the next setting.
14. Repeat steps 2-12 to complete the next time table program settings.
15. When finished, press [SET] again.

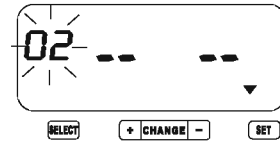
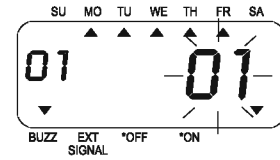
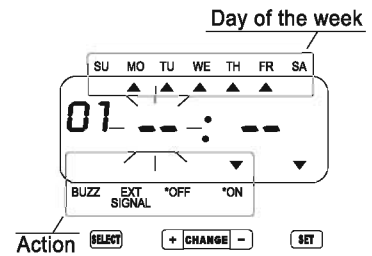

NOTE:

If you chose action 3 (external signal on) or action 4 (built-in buzzer on) the flashing will now last for the duration of the signal or buzzer setting (maximum 59 seconds).

How to Delete the Time Table Program Setting

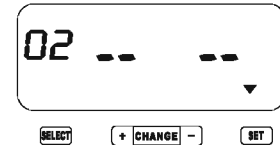
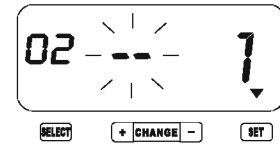
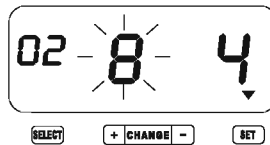
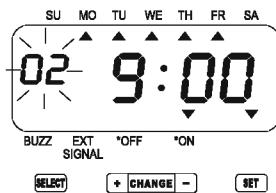

1. Use the [+][−] buttons to select the desired set number.
2. Press [SET] to enter.
3. Use the [+][−] buttons to select the weekday setting to be "--".
4. Press [SET] to confirm the setting value then the display turns to " -- -- ". Now the set is deleted.
5. When finished, press [SET] again.



4.10 Set the Customized Comment

The SP-250 allows you to enter Customized Comments under the PRINT ORDER setting. If you select the number "30" while in this option, you can print:

- . Three lines
- . Approximately 25 characters on each line
(depending on font size and margin settings)

How to Set a Customized Comment:

1. Press the [SELECT] button repeatedly, until the ▲ corresponds to the " PRINT ORDER" on the setting panel.
2. Use the [+] [-] buttons to select "30."
3. Press [SET] to confirm.
4. Use the [+] [-] buttons to select Print Position.

	Print Position
1	Left Orientated
2	Center Orientated
3	Right Orientated

5. Press [SET] to confirm.
6. Press the [SELECT] button repeatedly, until the ▲ corresponds to the " COMMENT" on the setting panel.
7. When the flashing turns to C1, press [SET] to enter the first comment line for setting.

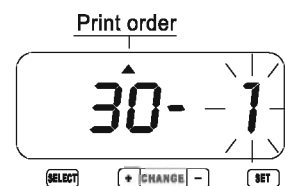
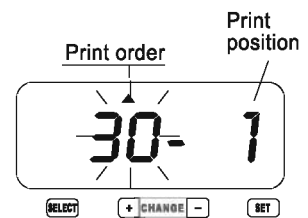
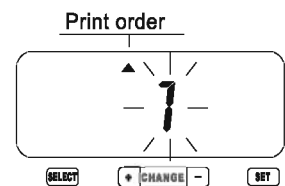

8. Press [SET] to enter the first character for setting.
9. Use the [+] [-] button to select the correct character code of character to print. (See page 21 for Alphanumeric Character Codes.)
10. Press [+] button to select the next character code for setting.
11. Press [SET] to enter.
12. Repeat steps 3-6 to complete the setting for the first comment line.
13. Press [SET] once again to enter the second comment line for setting.
14. Repeat steps 3-6 to complete the setting for the second comment line.
15. Press [SET] once again to enter the third comment line for setting.
16. Repeat steps 3-6 to complete the setting for the third comment line.
17. When finished, press [SET] again.

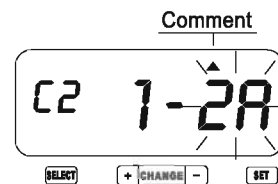
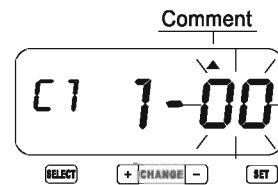

How to Correct Customized Comments

Use the code chart below to make changes, such as deleting a character or inserting a line.

Code	Meaning
F8	Insert Character
F9	Delete Character
FA	Insert Line
Fb	Delete Line
FC	Exchange Line 1 to 2
Fd	Exchange Line 2 to 3
FE	Exchange Line 1 to 3
FF	Delete All

Reset

To return all settings to the factory defaults, use a pointed object such as a pencil, to push the Reset switch (located on the back of the machine).

NOTE:

Pressing the Reset switch will delete all custom settings and revert to factory default settings. To enter new settings, please refer to settings sections of this guide.

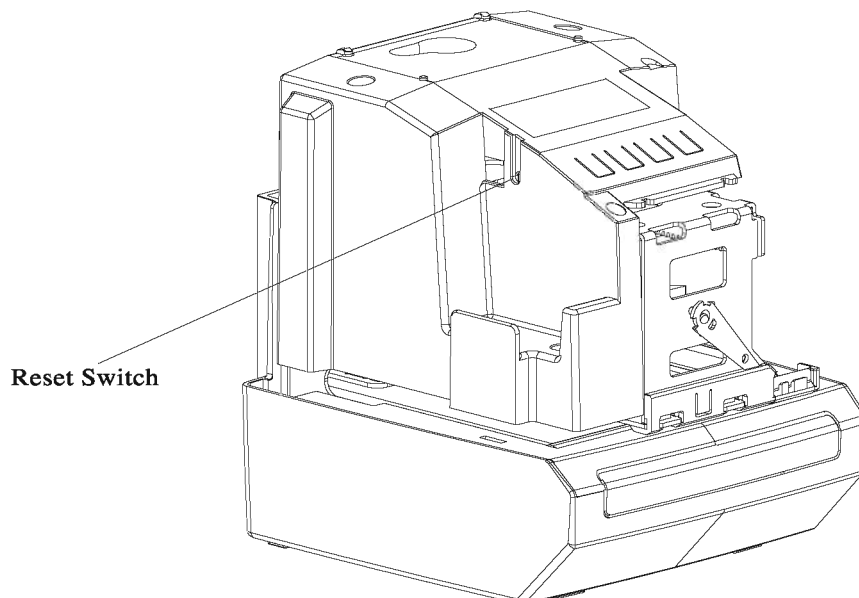

Replace the Ribbon Cassette

1. Using the key, unlock the cover and remove the ribbon cassette.
2. Hold the ribbon cassette by its tab and pull straight out.
3. Turn the knob of the new cassette in the direction of the arrow (clockwise) to tighten the ribbon.
4. Place the cassette into the SP-250 as illustrated below: The ribbon will snap into position. (Hint: Turning the knob on the ribbon cassette may make installation easier.)
5. Turn the cassette knob in the direction of the arrow to tighten the ribbon.
6. Replace the cover and lock with key.

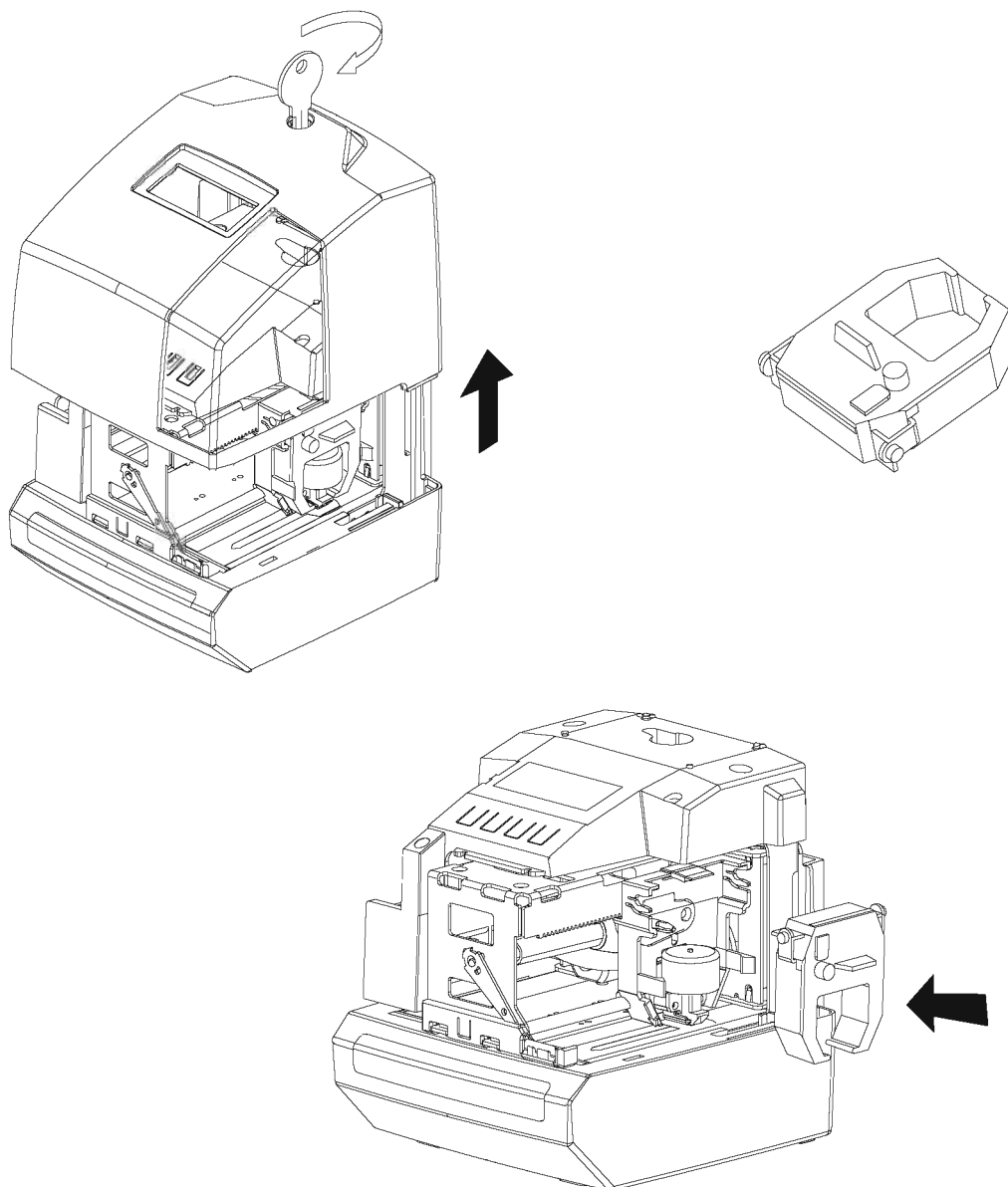

Install the Optional NiCad Battery

1. Using the key, unlock the cover and remove the NiCad battery.
2. Insert the battery connector into the compartment connector.
3. Replace the cover and lock with key.

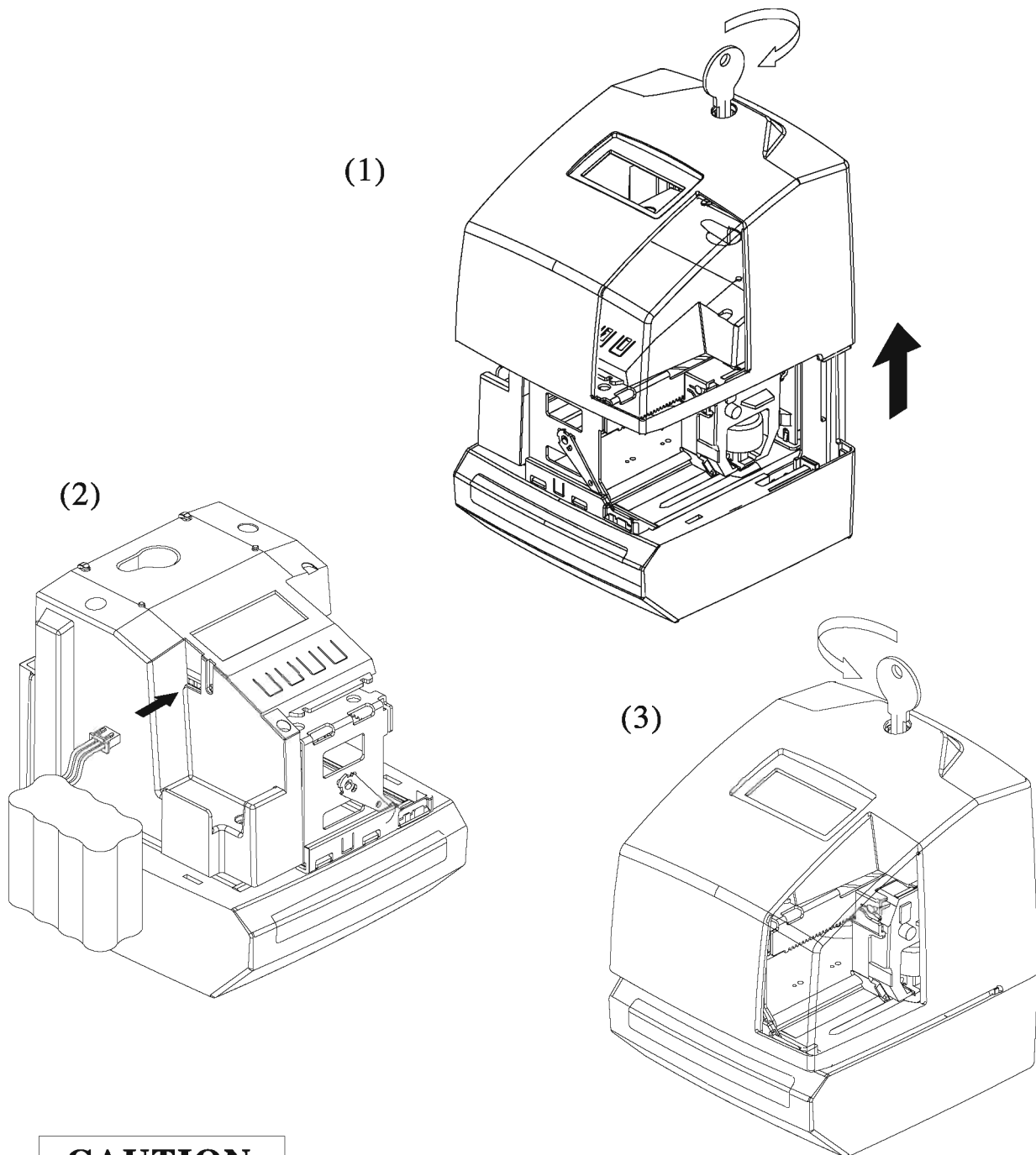

CAUTION

Replacing the battery incorrectly may cause risk of explosion.
Replace only with the same or equivalent battery type recommended by Icon Time Systems. Dispose of used batteries according to the manufacturer's instructions.

Troubleshooting

Number Code	Explanation
E-03	Cannot print. The printer head motor or the sensor does not operate properly.
E-04	Cannot print. The printer motor or home position sensor is not malfunctioning.
E-05	The card is not inserted in the Time Stamp properly.

Alphanumeric Character Code

Large (BOLD) Character

Code	Character	Code	Character	Code	Character
02	A	1b	Z	34	※4
03	B	1c	0	35	※5
04	C	1d	1	36	※6
05	D	1e	2	37	※7
06	E	1f	3	38	※8
07	F	20	4	39	※9
08	G	21	5	3a	※10
09	H	22	6	3b	※11
0a	I	23	7	3c	※12
0b	J	24	8	3d	※13
0c	K	25	9	3e	※14
0d	L	26	Year	3f	※15
0e	M	27	Month	40	,
0f	N	28	Date	41	*
10	O	29	DOW	42	+
11	P	2a	HH:MM	43	,
12	Q	2b	HH:MM:SS	44	-
13	R	2c	Number	45	.
14	S	2d	Number	46	/
15	T	2e	Number	47	:
16	U	2f	Number	48	;
17	V	30	Number	49	-
18	W	31	※1	4a	&
19	X	32	※2		
1a	Y	33	※3		

Code=26:2 digits setting of YEAR, Code=2A and 2b:AM/PM setting of HOUR,
Code=2C to 30: Number digits depend on the settings.

Large Character

Code	Character	Code	Character	Code	Character
4b	A	64	Z	78	※4
4c	B	65	0	7E	※5
4d	C	66	1	7F	※6
4E	D	67	2	80	※7
4F	E	68	3	81	※8
50	F	69	4	82	※9
51	G	6A	5	83	※10
52	H	6b	6	84	※11
53	I	6c	7	85	※12
54	J	6d	8	86	※13
55	K	6E	9	87	※14
56	L	6F	Year	88	※15
57	M	70	Month	89	'
58	N	71	Date	8A	*
59	O	72	DOW	8b	+
5A	P	73	HH:MM	8c	,
5b	Q	74	HH:MM:SS	8d	-
5c	R	75	Number	8E	.
5d	S	76	Number	8F	/
5E	T	77	Number	90	:
5F	U	78	Number	91	;
60	V	79	Number	92	_
61	W	7A	※1	93	&
62	X	7b	※2		
63	Y	7c	※3		

Code=6F:2 digits setting of YEAR, Code=73 and 74:AM/PM setting of HOUR,
Code=75 to 79: Number digits depend on the settings.

Small Character

Code	Character	Code	Character	Code	Character
<i>94</i>	A	<i>b5</i>	7	<i>d6</i>	HH:MM
<i>95</i>	B	<i>b6</i>	8	<i>d7</i>	HH:MM:SS
<i>96</i>	C	<i>b7</i>	9	<i>d8</i>	Number
<i>97</i>	D	<i>b8</i>	a	<i>d9</i>	Number
<i>98</i>	E	<i>b9</i>	b	<i>dA</i>	Number
<i>99</i>	F	<i>bA</i>	c	<i>dB</i>	Number
<i>9A</i>	G	<i>bB</i>	d	<i>dC</i>	Number
<i>9B</i>	H	<i>bC</i>	e	<i>dd</i>	※1
<i>9C</i>	I	<i>bD</i>	f	<i>dC</i>	※2
<i>9d</i>	J	<i>bE</i>	g	<i>dF</i>	※3
<i>9E</i>	K	<i>bF</i>	h	<i>E0</i>	※4
<i>9F</i>	L	<i>C0</i>	i	<i>E1</i>	※5
<i>A0</i>	M	<i>C1</i>	j	<i>E2</i>	※6
<i>A1</i>	N	<i>C2</i>	k	<i>E3</i>	※7
<i>A2</i>	O	<i>C3</i>	l	<i>E4</i>	※8
<i>A3</i>	P	<i>C4</i>	m	<i>E5</i>	※9
<i>A4</i>	Q	<i>C5</i>	n	<i>E6</i>	※10
<i>A5</i>	R	<i>C6</i>	o	<i>E7</i>	※11
<i>A6</i>	S	<i>C7</i>	p	<i>E8</i>	※12
<i>A7</i>	T	<i>C8</i>	q	<i>E9</i>	※13
<i>A8</i>	U	<i>C9</i>	r	<i>EA</i>	※14
<i>A9</i>	V	<i>CA</i>	s	<i>Eb</i>	※15
<i>AA</i>	W	<i>Cb</i>	t	<i>Ec</i>	,
<i>Ab</i>	X	<i>Cc</i>	u	<i>Ed</i>	*
<i>Ac</i>	Y	<i>Cd</i>	v	<i>Ee</i>	+
<i>Ad</i>	Z	<i>CE</i>	w	<i>EF</i>	,
<i>AE</i>	0	<i>CF</i>	x	<i>F0</i>	-
<i>AF</i>	1	<i>d0</i>	y	<i>F1</i>	.
<i>b0</i>	2	<i>d1</i>	z	<i>F0</i>	/
<i>b1</i>	3	<i>d2</i>	Year	<i>F3</i>	:
<i>b2</i>	4	<i>d3</i>	Month	<i>F4</i>	;
<i>b3</i>	5	<i>d4</i>	Date	<i>F5</i>	-
<i>b4</i>	6	<i>d5</i>	DOW	<i>F6</i>	&

Code=d2: 2 digits setting of YEAR, Code=d6 and D7:AM/PM setting of HOUR,
Code=d8 to dc: Number digits depend on the settings.

Language-specific Character

English

		※1	※2	※3	※4	※5	※6	※7	※8	※9	※10	※11	※12	※13	※14	※15
Character		#	\$	@	[\]	^	`	{		}	~	EURO		
Dots	Bold	9	9	9	7	8	7	8	5	7	5	7	7	8		
	Large	7	6	7	6	6	6	6	4	6	4	6	6	7		
	Small	6	6	6	5	6	5	4	3	5	4	5	6	6		

Spanish

		※1	※2	※3	※4	※5	※6	※7	※8	※9	※10	※11	※12	※13	※14	※15
Character		Pt	\$	@	i	Ñ	í	´	`	¨	ñ	}	~	EURO		
Dots	Bold	11	9	9	5	8	7	5	5	9	7	7	7	8		
	Large	8	6	7	4	7	6	4	4	7	7	6	6	7		
	Small	8	6	6	4	6	6	3	3	7	6	5	6	6		

German

		※1	※2	※3	※4	※5	※6	※7	※8	※9	※10	※11	※12	※13	※14	※15
Character		#	\$	§	Ä	Ö	Ü	^	`	ä	ö	ü	β	EURO		
Dots	Bold	9	9	8	8	8	8	8	5	7	7	7	8	8		
	Large	7	6	7	7	7	7	6	4	7	6	6	7	7		
	Small	6	6	6	6	6	6	4	3	5	5	5	6	6		

French

		※1	※2	※3	※4	※5	※6	※7	※8	※9	※10	※11	※12	※13	※14	※15
Character		#	\$	à	°	ç	§	^	`	é	ù	è	¨	EURO		É
Dots	Bold	9	9	7	4	7	8	8	5	7	7	7	9	8		8
	Large	7	6	7	4	6	7	6	4	6	6	6	7	7		7
	Small	6	6	6	4	5	6	4	3	5	5	5	7	6		6

Italian

		※1	※2	※3	※4	※5	※6	※7	※8	※9	※10	※11	※12	※13	※14	※15
Character		#	\$	@	°	\	é	^	ù	à	ò	è	ì	EURO		
Dots	Bold	9	9	9	4	8	7	8	7	7	7	7	5	8		
	Large	7	6	7	4	6	6	6	6	7	6	6	4	7		
	Small	6	6	6	4	6	5	4	5	5	5	5	4	6		

Portuguese

		※1	※2	※3	※4	※5	※6	※7	※8	※9	※10	※11	※12	※13	※14	※15
Character		#	\$	@	[\]	^	`	{		}	~	EURO		
Dots	Bold	9	9	9	7	8	7	8	5	7	5	7	7	8		
	Large	7	6	7	6	6	6	6	4	6	4	6	6	7		
	Small	6	6	6	5	6	5	4	3	5	4	5	6	6		

Numeric

		※1	※2	※3	※4	※5	※6	※7	※8	※9	※10	※11	※12	※13	※14	※15
Character		#	\$	@	[\]	^	`	{		}	~	EURO		
Dots	Bold	9	9	9	7	8	7	8	5	7	5	7	7	8		
	Large	7	6	7	6	6	6	6	4	6	4	6	6	7		
	Small	6	6	6	5	6	5	4	3	5	4	5	6	6		

Cautions

- . This machine is for indoor use only. Do not install outdoors, or where it may be exposed to rain.
- . Keep away from heat radiators, air ducts, moisture, and mechanical shock vibration.
- . Always plug the machine into the correct power source.
- . Do not allow any liquid or solid objects to fall onto/into the machine.
- . If machine malfunctions, is damaged in any matter, or has a damaged cord or plug, do not operate: Return to an authorized service facility or examination, repair, or adjustment.
- . If machine malfunctions, unplug it immediately. Do not operate until checked by authorized service facility.
- . Place the SP-250 near an easily accessible outlet for plug-in.

Specifications

Power Rating:	110-120V~ refer to label of each machine
Amp:	0.2 Amps
Dimensions:	6.5" x 5."x 7.1" in ³ (D x W x H) (16.5 x 15 x 18 cm ³)
Weight:	5.5 lbs (2.5 kg)
Appropriate Temperature Range:	32°F - 104°F (0°C -40°C)
Conditions:	10-80% RH