



TIME CLOCK WORLD

888 534-5994



ES700

USER MANUAL



WARNING

This equipment has been tested and found to comply with the limits for a Class A digital device, pursuant to Part 15 of FCC Rules. These limits are designed to provide reasonable protection against harmful interference when the equipment is operated in a commercial environment. This equipment generates, uses, and can radiate radio frequency energy and, if not installed and used in accordance with the instruction manual, may cause harmful interference to radio communications. Operation of this equipment in a residential area is likely to cause harmful interference in which case the user will be required to correct the interference at his or her own expense.

Caution: Changes or modifications not expressly approved by the party responsible for compliance could void the user's authority to operate the equipment.

THIS DIGITAL APPARATUS DOES NOT EXCEED THE CLASS A LIMITS FOR RADIO NOISE EMISSIONS FROM DIGITAL APPARATUS AS SET OUT IN THE RADIO INTERFERENCE REGULATIONS OF THE CANADIAN DEPARTMENT OF COMMUNICATIONS.

LE PRÉSENT APPAREIL NUMÉRIQUE N'ÉMET PAS DE BRUITS RADIOÉLECTRIQUES DÉPASSANT LES LIMITES APPLICABLES AUX APPAREILS NUMÉRIQUES DE CLASSE A PRESCRITES DANS LE RÈGLEMENT SUR LE BROUILLAGE RADIOÉLECTRIQUE ÉDICTÉ PAR LE MINISTÈRE DES COMMUNICATIONS DU CANADA.

This product utilizes a battery that contains Perchlorate Material.
Perchlorate Material - special handling may apply, See
www.dtsc.ca.gov/hazardouswaste/perchlorate

This manual is the confidential proprietary document solely for the use of Acroprint Time Recorder customers. Material in this manual is subject to change without notice and does not represent an obligation on the part of Acroprint Time Recorder. No part of this manual may be reproduced or transmitted in any form by any means without the express written permission of Acroprint Time Recorder.

This User's Manual has been carefully prepared to cover all aspects of the time recorder's use. Before using the time recorder, we recommend you carefully read this manual to familiarize yourself with the Time Recorder.

ALL RIGHTS RESERVED.

© 2001 & 2006 ACROPRINT TIME RECORDER









PRECAUTIONS







This user's manual is prepared for safe and proper use of the unit. Please follow all the instructions to avoid possible danger to yourself or others and damage to the unit.



Signs

Various warnings and cautions are provided throughout this manual along with signs. Remember each sign and its explanation listed below for your safety and proper operation of the unit.











	Warning	Improper handling may cause bodily accidents including death and serious injury.
	Caution	Improper handling may harm the human body or material.

	Improper handling may cause electric shock DANGER.		"Must-Do" sign.
	DO NOT disassemble the unit.		Be sure to remove the line cord plug from the outlet.
	"Don't" sign.		

 Warning	
	Do not disassemble the unit. There is a high voltage present inside, possibly leading to an electric shock.
	Do not modify the unit. Modifications may cause a fire and/or electric shock.
	If any anomaly occurs, for example, heat or smoke is generated or an odor is emitted, unplug the unit immediately and contact your dealer for servicing. There is a danger that further use may cause a fire or electric shock.
	Do not use any voltage of the power source other than designated. Do not share a single outlet with another plug. These may lead to fire or shock hazards.
	Do not damage, break, or modify the power cord. Do not put a heavy object on, pull, or forcefully bend the cord, either. These may damage the cord, possibly resulting in a fire or electric shock.

	If foreign matter should get in the unit (including a piece of metal, water, or liquid), disconnect the plug from the outlet immediately and contact your dealer for servicing. There is a danger that further use may cause a fire or electric shock.
	Do not plug or unplug the unit with a wet hand. You may get an electric shock.

	Caution
---	----------------

	Do not place the unit on an uneven or tilted surface. This may result in injuries due to the unit dropping or falling off.
	Do not put a water-filled container or a metal object on top of the unit. If water is spilled or the metallic object slips inside, a fire or shock hazard may occur.
	Do not install the unit in a humid or dusty environment. It may cause a fire or electric shock.
	Do not place the unit near kitchen counter or humidifier. Oil, smoke, or steam generating from them may cause fire or shock hazards.
	Do not yank the power cord to disconnect from the outlet. Hold the plug with your hand to do so, or the cord may be damaged, possibly leading to a fire or electric shock.
	Remove the line cord plug from the outlet before transferring the unit, or it may damage the cord, possibly leading to a fire or electric shock.
	Be careful not to contact the print head, as you may get hurt or burned.
	Make sure to insert the power plug as far as it will go. Improper insertion of the plug may develop fire or shock hazards.
	Do not insert or drop any other time card than specified into the slot. Such misuse may cause a fire or electric shock.
	If the unit should be dropped or the case be broken, unplug the unit and contact your dealer for servicing. Further use may lead to a fire or shock hazard.

CONTENTS

Introduction & features	1
Before using your time recorder	2
Quick easy setup	3
How to program the recorder	4
Setting the display format	
Setting the time	5
Setting the date	6
Setting the 12/24 hour display format	7
Setting the print order	8
Setting the print style	
Setting the year digit	9
Setting the hour/min	10
Disabling the leading zero	11
Setting the comment	12
Setting the language	13
Setting the print method	14
Setting the daylight saving time	
Setting the starting date of daylight saving time.....	16
Setting the ending date of daylight saving time.....	17
Deleting the daylight saving time setting	18
Setting the password	
Registering the password.....	19
Using the password to access program	20
Canceling the password	21
Resetting	23
Wall mounting.....	24
Replacing the ribbon cassette	25
Troubleshooting	27
Specifications.....	28

INTRODUCTION & FEATURES

INTRODUCTION:

Thank you for purchasing an Acroprint Model ES700 Time Recorder. We are confident this time recorder will give you full satisfaction. Items such as the time and date are preset at the factory. After plugging in the AC power, the recorder may be used immediately. However, we recommend reading this manual before you start using your time recorder.

FEATURES:

Main applications: payroll/job cost recorder or time stamp.

- Quartz timing for accuracy
- Digital LCD display
(Date, Hour, Minute, Day of the week indication)
- Dot-Matrix printer
- Perpetual calendar
- Automatic date, day, and month change
- 3-way print activation
 - Manual
 - Automatic
 - Semi-automatic
- Prints 4 languages: English, French, Spanish, Portuguese
- Prints seconds
- 12 or 24-hour format
- Regular minute, tenths, twentieths, or hundredths of an hour
- 2 or 4-digit year print
- 13 preprogrammed comments
- Adjustable print position

Caution:

Do not use in places:

- Subject to high humidity and dust.
- Exposed to strong or continuous vibrations.
- Exposed to direct sunlight.
- Affected by chemical or ozone.

Place the time clock close to the wall outlet so that it is easily accessible to disconnect.

The temperature range in which all functions of the time recorder will operate correctly is from -5°C to 45°C. Be sure to place your time recorder only in locations where the temperature range is not exceeded and has no sharp fluctuations in temperature.

BEFORE USING YOUR TIME RECORDER

Package Contents

Unpack the time recorder and check its contents to ensure that the time recorder unit and all accessories as shown below are included.

ACCESSORIES INCLUDED

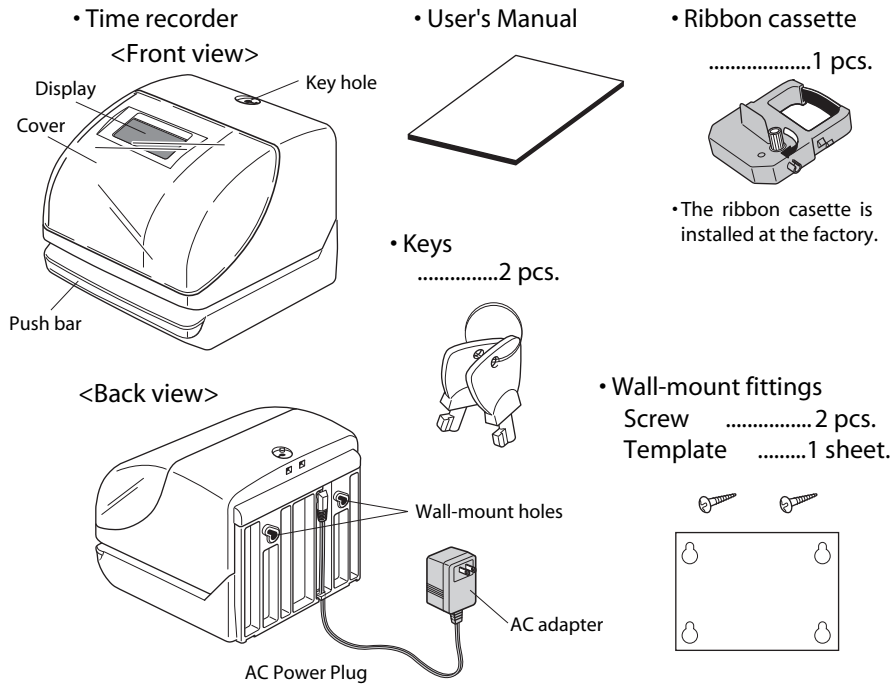

LOCATION OF COMPONENTS

It is important to become familiar with the time recorder before setting it up and using it.

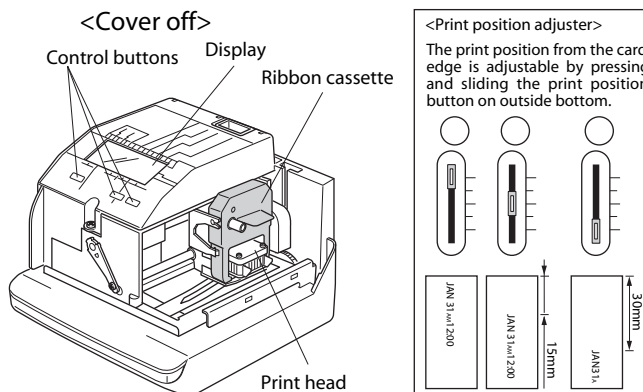

PRINT POSITION ON TIME CARD

The print position from the card edge is adjustable by pressing and sliding the print position button located on the bottom of the recorder. Maximum distance from edge of form to print is approximately 1 3/16" (30mm)

QUICK EASY SETUP

Step 1

Unlock the key and remove the top case.

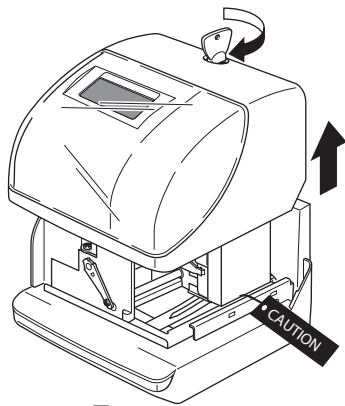

Step 3

Plug the AC cord into the AC outlet.
The recorder is now ready to be set.

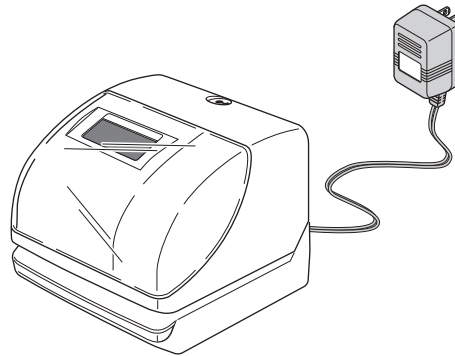

Step 2

Remove the PROTECTION PAD.
Plug the AC adapter into the time recorder.

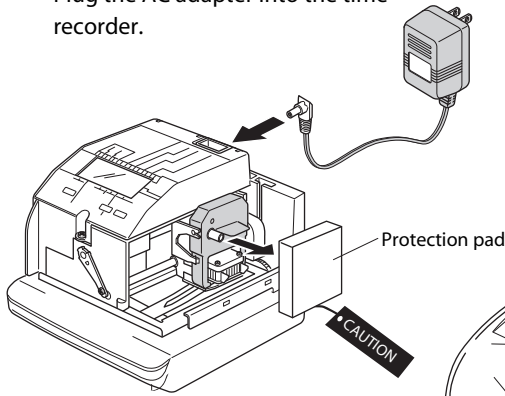

Step 4

Replace the cover and lock.
Insert a card.

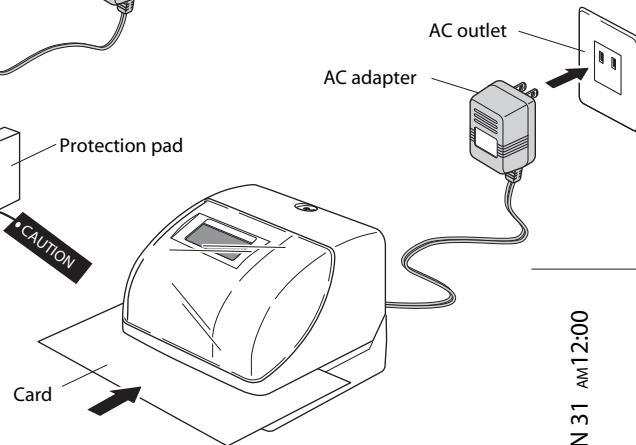

JAN 31 AM 12:00

(print example)

HOW TO PROGRAM THE RECORDER

To enter the program setting mode, one must plug the AC adapter into the AC outlet and remove the cover. Next press the **SELECT** button once. Then the recorder changes into the program mode showing the ▲ on the display positioned under the "TIME" mark.

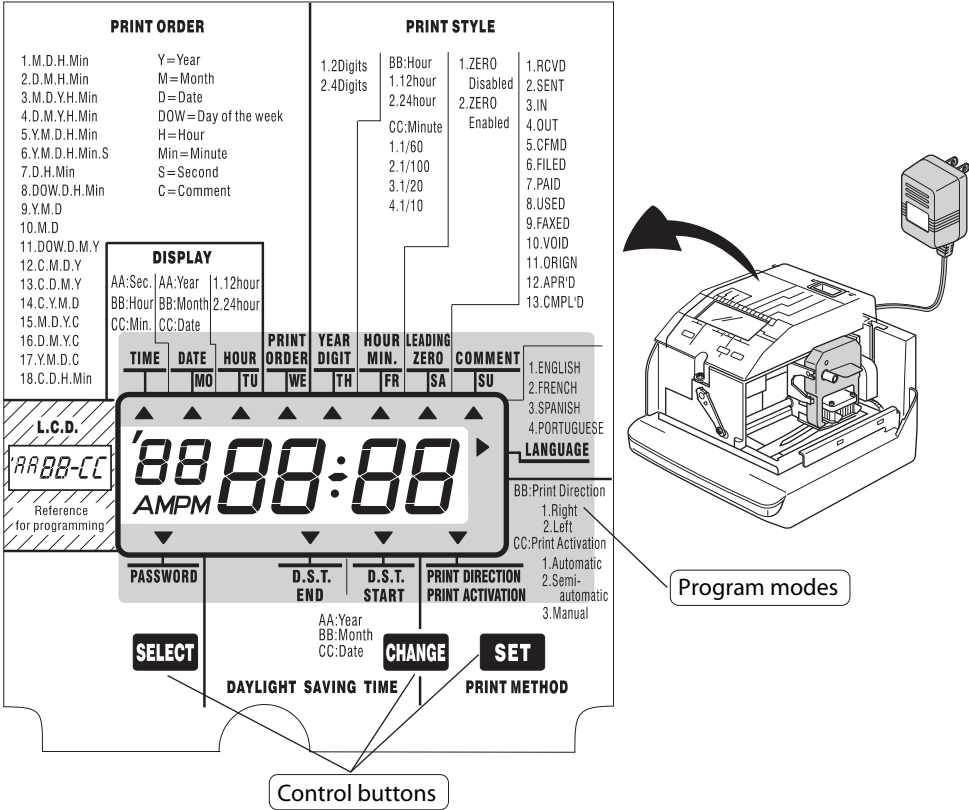

FUNCTION OF 3 CONTROL BUTTONS

- SELECT**: Press the **SELECT** button to choose the program setting mode. The selected program mode is indicated by the ▲ mark on the display.
- CHANGE**: Pressing the **CHANGE** button allows you to cycle through the options.
- SET**: Pressing the **SET** button allows you to set the option shown on the display.

SETTING THE DISPLAY FORMAT

SETTING THE TIME

Ex: Set the time from 10:08 to 10:09.

Step 1

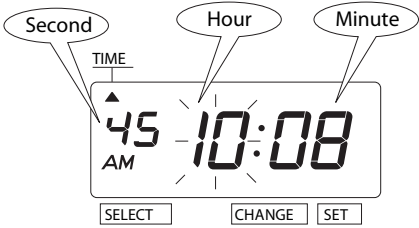

Press the **SELECT** button and position the ▲ under the "TIME" mark. One can see that the "hour" flashes. (the flashing means that the number can be changed.)



Change the "Hour"
In case of the example, press the **SET** button because the hour is not to be changed.
At that moment, the flashing changes from "Hour" to "Minute".

Step 2



Change the "Minute"
In this case, press the **CHANGE** button to set at "09". And then press the **SET** button.
At that moment, the "Second" starts to run from "00".

Step 3



After you finish setting the time, press the **SET** button once again.
Now the hour/minute setting has been completed. Replace the cover and lock.

Important: Printing will not occur unless Step 3 is completed.

SETTING THE DATE

Ex: Change the date from October 20, 2006 to October 21, 2006.

Step 1

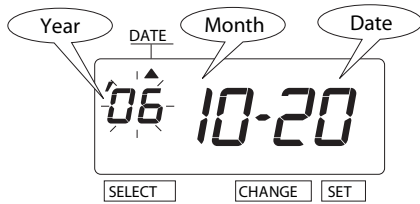

Press the **SELECT** button, and position the ▲ under the "DATE".
One can see that, the "Year" flashes.

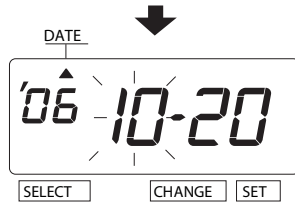

Change the "Year"
In case of the example, press the **SET** button because the year 2006 is not to be changed.
At that moment, the flashing changes from "Year" to "Month".

Step 2

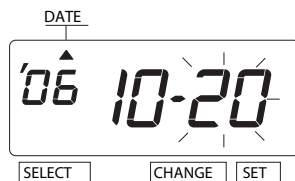

Change the "Month"
In case of the example, press the **SET** button because the month is not to be changed.
At that moment, the flashing changes from "Month" to "Date".

Step 3

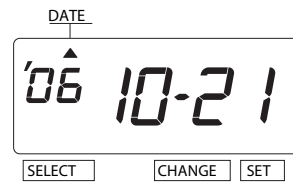

Change the "Date"
Press the **CHANGE** button to set at "21".
And then press the **SET** button.

Step 4



After you finish setting the date, press the **SET** button once again.
Now the date setting has been completed. Replace the cover and lock.

Important: Printing will not occur unless Step 4 is completed.

SETTING THE 12/24 HOUR DISPLAY FORMAT

Ex: Set the hour format to 24 hour.

Step 1

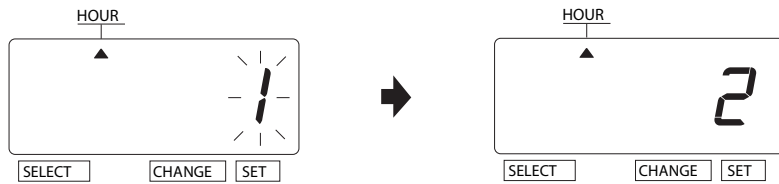

Press the **SELECT** button and position the ▲ under the "HOUR" mark. At that moment, the flashing digit indicates "Hour Display Format Options".

In case of the example, press the **CHANGE** button to set at "2". And then press the **SET** button.

	Hour Display Format Options	Display
1.	12 hour	PM 3:00
2.	24 hour	15:00

Step 2



After you finish setting the 12/24 hour display format, press the **SET** button once again. Now the 12/24 hour setting has been completed. Replace the cover and lock.

Important: Printing will not occur unless Step 2 is completed.

SETTING THE PRINT ORDER

Ex: Set the print order to "Month, Date, Year, Hour, Minute".

Step 1

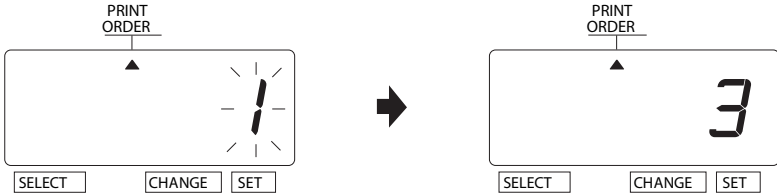

Press the **SELECT** button and position the ▲ under the "PRINT ORDER" mark. At that moment, the flashing digit indicates "Print Order Options".

In case of the example, press the **CHANGE** button to set at "3". And then press the **SET** button.

Y=Year, M=Month, D=Date, DOW=Day of the week, H=Hour, Min=Minute
S=Second, C=Comment

	Print Order Options	Print Example
1.	M, D, H, Min	JAN 31 AM10:00
2.	D, M, H, Min	31 JAN AM10:00
3.	M, D, Y, H, Min	JAN 31 '06 AM10:00
4.	D, M, Y, H, Min	31 JAN '06 AM10:00
5.	Y, M, D, H, Min	'06 JAN 31 AM10:00
6.	Y, M, D, H, Min, S	'06 JAN 31 AM 10:00:00
7.	D, H, Min	31 AM10:00
8.	DOW, D, H, Min	TU, 31 AM10:00
9.	Y, M, D	'06 JAN 31
10.	M, D	JAN 31
11.	DOW, D, M, Y	TU, 31 JAN '06
12.	C, M, D, Y	SENT JAN 31 '06
13.	C, D, M, Y	SENT 31 JAN '06
14.	C, Y, M, D	SENT '06 JAN 31
15.	M, D, Y, C	JAN 31 '06 SENT
16.	D, M, Y, C	31 JAN '06 SENT
17.	Y, M, D, C	'06 JAN 31 SENT
18.	C, D, H, Min	SENT 31 AM10:00

Step 2



After you finish setting the print order, press the **SET** button once again. Now the print order setting has been completed. Replace the cover and lock.

Important: Printing will not occur unless Step 2 is completed.

SETTING THE PRINT STYLE

SETTING THE YEAR DIGIT

Ex: Set the year imprint to 4 digits.

Step 1

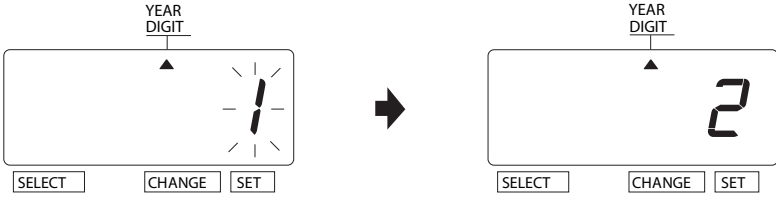

Press the **SELECT** button and position the ▲ under the "YEAR DIGIT" mark. At that moment, the flashing digit indicates "Year Digit Options".

In case of the example, press the **CHANGE** button to set at "2", and then press the **SET** button.

	Year Digit Options	Print Example
1.	2 Digits	JAN 31 '06 AM10:00
2.	4 Digits	JAN 31 2006 AM10:00

Step 2



After you finish setting the year digit, press the **SET** button once again. Now the year digit setting has been completed. Replace the cover and lock.

Important: Printing will not occur unless Step 2 is completed.

SETTING THE HOUR/MIN.

Ex: Set the print style of the "Hour" and "Minute" to 24 hour and 1/100min.

Step 1

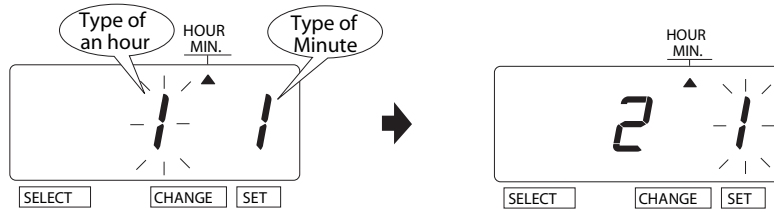

Press the **SELECT** button and position the ▲ under "HOUR/MIN" mark. At that moment, the flashing digit indicates "Hour Options".

In case of the example, press the **CHANGE** button to set at 2. And then press the **SET** button. At that moment, the flashing changes from "Hour" to "Minute".

Change the "Hour".

	Hour Options	Print Example
1.	12 Hour	JAN 31 PM3:00
2.	24 Hour	JAN 31 15:00

Step 2

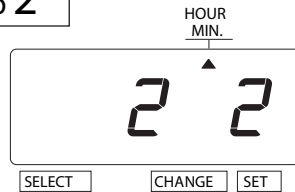

In case of the example, press the **CHANGE** button to set at "2". And then press the **SET** button.

Change the "Minute".

	Order Options	Print Example		Order Options	Print Example
1.	1/60 Min.	JAN 31 AM12:10	3.	1/20 Min. (=5/100 Min.)	JAN 31 AM12.15
2.	1/100 Min.	JAN 31 AM12.17	4.	1/10 Min.	JAN 31 AM12.1

Step 3



After you finish setting the hour/minute, press the **SET** button once again. Now the hour/minute setting has been completed. Replace the cover and lock.

Important: Printing will not occur unless Step 3 is completed.

DISABLING THE LEADING ZERO

Ex. Set the leading zero to "Zero: Disabled".

Step 1

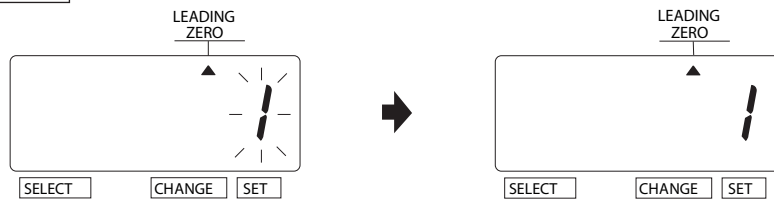

Press the **SELECT** button and position the ▲ under "LEADING ZERO" mark. At that moment, the flashing digit indicates "Leading Zero Options".

In case of the example, press the **CHANGE** button to set at "1". And then press the **SET** button.

	Leading Zero Options	Print Example
1.	ZERO Disabled	JAN 1 PM3:00
2.	ZERO Enabled	JAN 01 PM03:00

Step 2



After you finish setting the leading zero, press the **SET** button once again. Now the leading zero setting has been completed. Replace the cover and lock.

Important: Printing will not occur unless Step 2 is completed.

SETTING THE COMMENT

Ex: Set the comment to "SENT".

Step 1

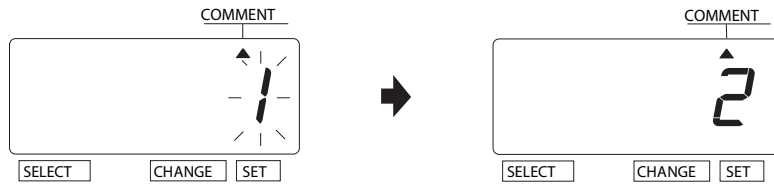

Press the **SELECT** button and position the ▲ under "COMMENT" mark. At that moment, the flashing digit indicates "Comment Options". (The flashing means it can be changed)

In case of the example, press the **CHANGE** button to set at "2". And then press the **SET** button.

	Comment Options	Print Example
1.	RCVD (Received)	JAN 31 '06 RCVD
2.	SENT	JAN 31 '06 SENT
3.	IN	JAN 31 '06 IN
4.	OUT	JAN 31 '06 OUT
5.	CFMD (Confirmed)	JAN 31 '06 CFMD
6.	FILED	JAN 31 '06 FILED
7.	PAID	JAN 31 '06 PAID
8.	USED	JAN 31 '06 USED
9.	FAXED	JAN 31 '06 FAXED
10.	VOID	JAN 31 '06 VOID
11.	ORIGN (Original)	JAN 31 '06 ORIGN
12.	APR'D (Approved)	JAN 31 '06 APR'D
13.	CMPL'D (Completed)	JAN 31 '06 CMPL'D

Step 2



After you finish setting the comment, press the **SET** button once again. Now the comment setting has been completed. Replace the cover and lock.

Important: Printing will not occur unless Step 2 is completed.

SETTING THE LANGUAGE

This setting is available if one selects "Month," "Day of the week" or "Comment" in previous "PRINT ORDER"

Ex: Set the print language into French.

Step 1

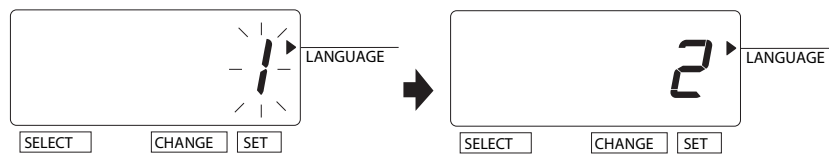

Press the **SELECT** button and position the ▲ next to "LANGUAGE" mark. At that moment, the flashing digit indicates "Print Language Options".

In case of the example, press the **CHANGE** button to set at "2". And then press **SET** button.

	Print Language Options	Print Example
1.	ENGLISH	WE, 27 DEC '06 OUT 31 AM10:00
2.	FRENCH	ME, 27 DEC '06 SORT 31 AM10:00
3.	SPANISH	MI, 27 DIC '06 SAL 31 AM10:00
4.	PORTUGUESE	QA, 27 DEZ '06 SAIDA 31 AM10:00

Step 2



After you finish setting the language, press the **SET** button once again. Now the language setting has been complete. Replace the cover and lock.

Important: Printing will not occur unless Step 2 is completed.

SETTING THE PRINT METHOD

Ex: Change the print direction to "Left" and the print activation to "Manual".

Step 1

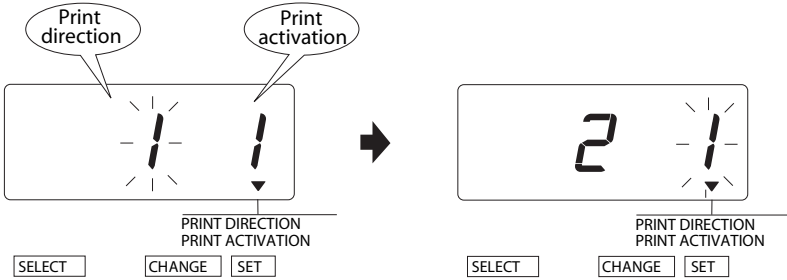

Press the **SELECT** button and position the ▼ over at the "PRINT DIRECTION; PRINT ACTIVATION".
At that moment, the flashing digit indicates "Print Direction Options".

In case of the example, press the **CHANGE** button to set at "2" And then press the **SET** button.
The flashing changes from the "PRINT DIRECTION" to the "PRINT ACTIVATION".

Change the "Print Direction".

	Print Direction Options
1.	Right-hand margin of form
2.	Left-hand margin of form

Step 2

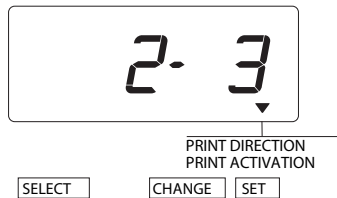

In case of the example, press the **CHANGE** button to set at "3". And then press the **SET** button.

Change the "Print Activation".

	Print Activation Options
1.	Automatic
2.	Semi-automatic
3.	Manual

Step 3



After you finish setting the print method, press the **SET** button once again. Now the print method setting has been completed. Replace the cover and lock.

Important: The recorder will not print if you do not complete Step 2.

Automatic will allow the clock to print by simply inserting a card or form.
 Semi-automatic will allow the clock to print by pressing the push bar only when a card or form is inserted. (will print only when the card or paper reaches the sensor)
 Manual will allow the clock to print by pressing the push bar. (will print even when the card or form does not reach the sensor)

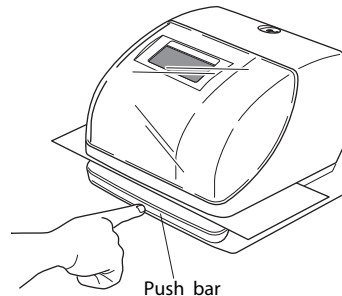

SETTING THE DAYLIGHT SAVING TIME

Ex: Start date Sunday, March 11, 2007.
 End date Sunday, November 4, 2007.

If set as the above, the unit remembers the start date as the second Sunday of March and the end date as the first Sunday in November. Once set, the unit automatically updates the settings every year thereafter. No further manual setting is necessary.

SETTING THE STARTING DATE OF DAYLIGHT SAVING TIME

Step 1

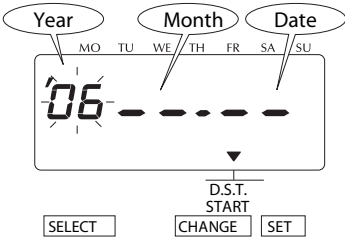

Press the **SELECT** button and position the ▼ over the "D.S.T.START". At that moment the "Year" flashes. (The flashing means it can be changed)

Change the "Year"
 In case of the example, press the **CHANGE** button to set at "07". And then press the **SET** button. At that moment, the flashing changes from "Year" to "Month".

Step 2

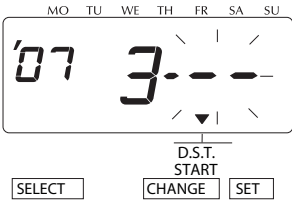

Change the "Month"
 Press the **CHANGE** button to set at "3". And then press the **SET** button. At that moment, the flashing changes from "Month" to "Date".

Step 3

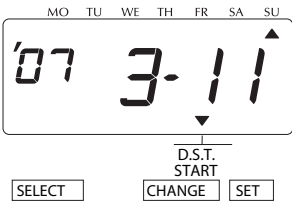

Change the "Date"
 Press the **CHANGE** button to set at "11". And then press the **SET** button.

Step 4



After you finish setting the starting date of D.S.T., press the **SET** button once again. Now the starting date of D.S.T. setting has been completed. Go on to the "SETTING THE ENDING DATE OF DAYLIGHT SAVING TIME".

SETTING THE ENDING DATE OF DAYLIGHT SAVING TIME

Ex: Daylight saving time ends on Sunday, November 4, 2007.

Step 1

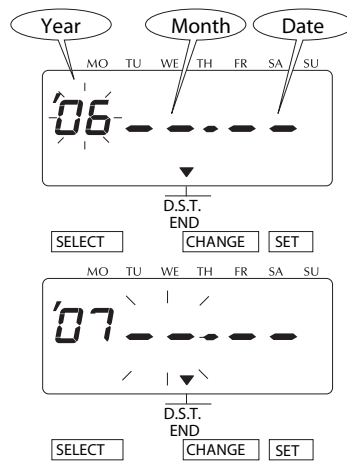

Press the **SELECT** button and position the ▼ over the "D.S.T. END".
At that moment, the "Year" flashes.

Change the "Year"

In case of the example, press the **CHANGE** button to set at "07". And then press the **SET** button.
At that moment, the flashing changes from "Year" to "Month".

Step 2

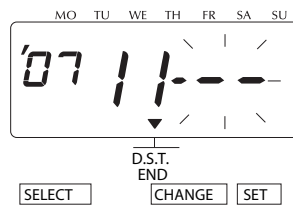

Change the "Month"

Press the **CHANGE** button to set at "11".
And then press the **SET** button.
At that moment, the flashing changes from "Month" to "Date".

Step 3

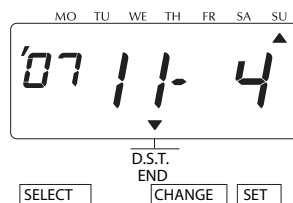

Change the "Date"

Press the **CHANGE** button to set at "4".
And then press the **SET** button.

Step 4



After you finish setting the ending date of D.S.T., press the **SET** button once again.
Now the ending date of D.S.T. setting has been completed. Replace the cover and lock.

Important: Printing will not occur unless Step 4 is completed.

DELETING THE DAYLIGHT SAVING TIME SETTING

To delete and cancel the daylight saving time, change the display of "Month" of the starting setting to " - - -".

Ex: Change March 11, 2007 of "D.S.T START" and delete daylight saving time setting.

Step 1

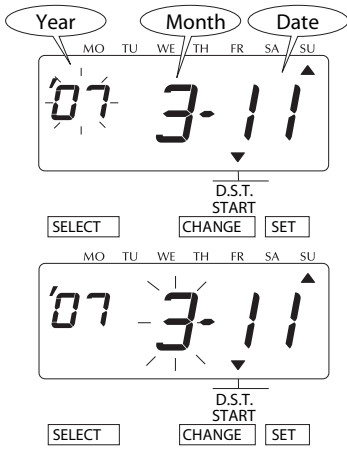

Press the **SELECT** button and position the **▲** over the D.S.T. START. At that moment, the "Year" flashes.

Next, press the **SET** button. At that moment, the flashing changes from "Year" to "Month".

Step 2

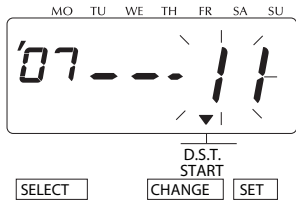

Press the **CHANGE** button to set at " - - -". And then press the **SET** button.

At that moment, the flashing changes from "Month" to "Date".

Step 3

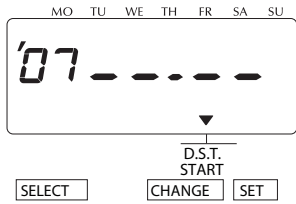

Press the **SET** button again. At that moment, the flashing changes from "11" to " - - -".

Step 4



Press the **SET** button once again. Now the D.S.T. deleting has been completed. Replace the cover and lock.

Important: Printing will not occur unless Step4 is completed.

SETTING THE PASSWORD

When the password is set, you will be required to enter the password. If the password you entered does not coincide with the setting, you cannot change the setting values. You may select any 4-digit number from 0001 to 9998 as your password. Note: "0000" and "9999" are not valid passwords.

REGISTERING THE PASSWORD

Ex: Set the password to "1234"

Step 1

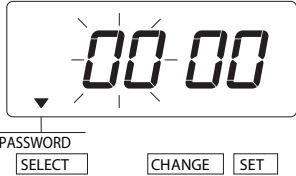

Press the **SELECT** button and position the ▲ mark at the "PASSWORD". The first two digits flash.

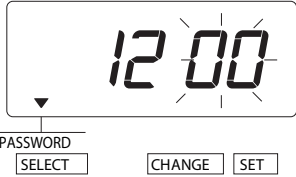

In case of the example, press the **CHANGE** button to select "12", and press the **SET** button. The flashing changes to the last two digits.

Step 2

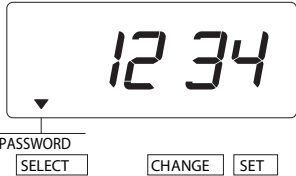

Using the **CHANGE** button, select "34" and press the **SET** button.

Step 3



After the password has been set, press the **SET** button once more. The password is now set. Replace the cover and lock.

Important: Printing will not occur unless Step 3 is completed.

USING THE PASSWORD TO ACCESS PROGRAM

If you want to change any program settings, you are required to enter the current password first. "9999" will be displayed when you press the **SELECT** button before entering.

Ex: Password "1234"

Step 1

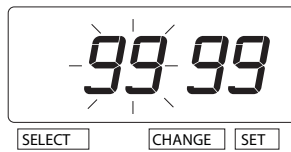

Press the **SELECT** button. At that moment "9999" is displayed and first two digits flashes.

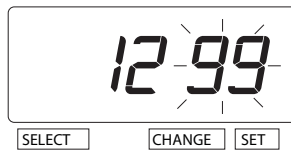

In the example, press the **CHANGE** button to set at "12". And then press the **SET** button.

At that moment, the flashing changes to last two digits.

Step 2



In case of the example, press the **CHANGE** button to set at "34". And then press the **SET** button. At that moment, the ▲ mark indicates the "TIME".

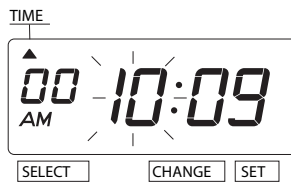

Step 3

Select desired setting mode by pressing the **SELECT** button. Then make settings as explained.

CANCELING THE PASSWORD

The code "0000" will cancel the password when entered. You may select a different 4-digit password from 0000 to 9998 using this same method.

Ex: Cancel the password "1234".

Step 1

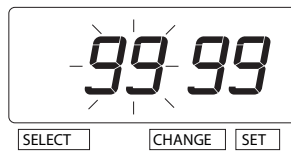

Press the **SELECT** button, at that moment "9999" is displayed and first two digits flashes.

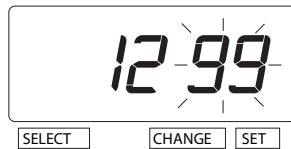

In case of the example, press the **CHANGE** button to set at "12". And then press the **SET** button. At that moment, the flashing changes to last two digits.

Step 2

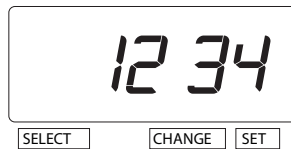

In case of the example, press the **CHANGE** button to set at "34". And then press the **SET** button.

At that moment, the ▲ mark indicates the "TIME".

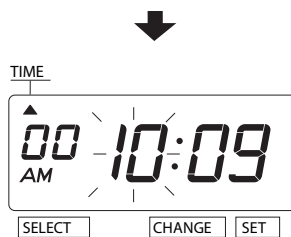

Step 3

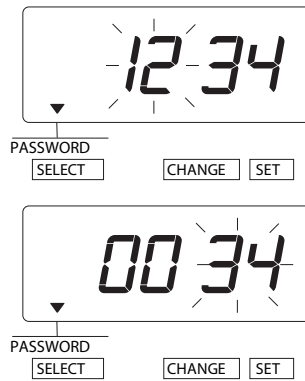

Press the **SELECT** button and position the ▲ mark at the "PASSWORD". At that moment, first two digits "12" flashes.

Press the **CHANGE** button to set at "00". And then press the **SET** button. At that moment, the flashing changes to last two digits "34".

Step 4

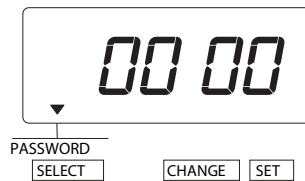

Press the **CHANGE** button to set at "00". And then press the **SET** button.

Step 5



After you finish canceling the password, press the **SET** button once again. Now the password canceling has been completed. Replace the cover and lock.

Important: Printing will not occur unless Step 5 is completed.

RESETTING

To return all settings to the factory defaults, push the reset switch with a pointed implement.

NOTICE: All custom settings made by individuals will be deleted and will revert to the factory defaults when the reset switch is pushed. To make new settings, please refer to "Setting ...".

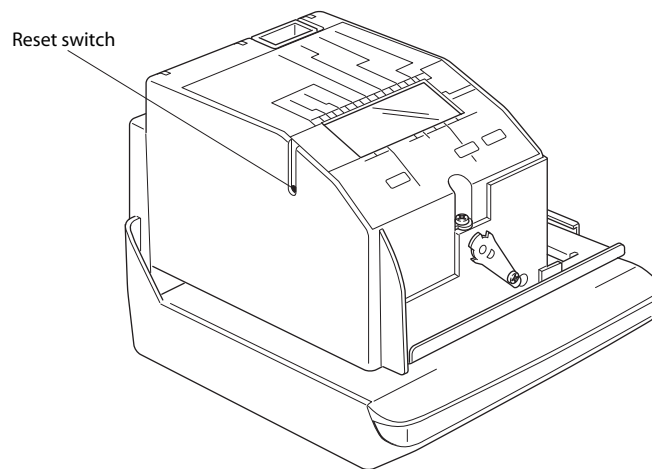

WALL MOUNTING

Caution: The supplied screws are intended for use on a thick wooden wall or wooden column. Do not use any other materials. The time clock may come off if used on other materials.

Step 1

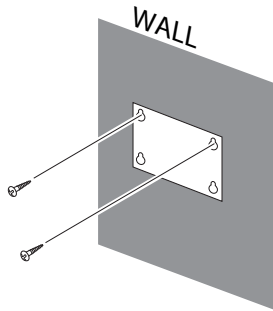

Install the supplied wall-mount screws into a wall by using the template. Be sure to keep about 6mm (1/4") of the screw head away from the wall. The recommended height from the floor to the bottom of the ES700 is 45".

Step 3

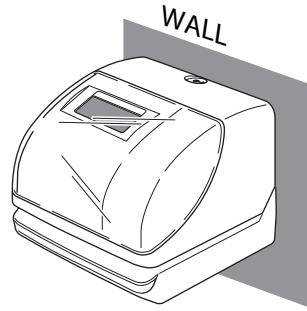

Replace cover and lock.

Step 2

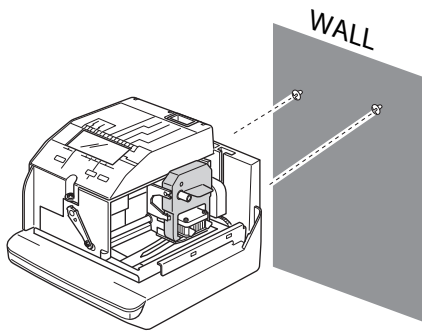

Unlock the key and remove the cover. And then hang it on the wall.

REPLACING THE RIBBON CASSETTE

Step 1

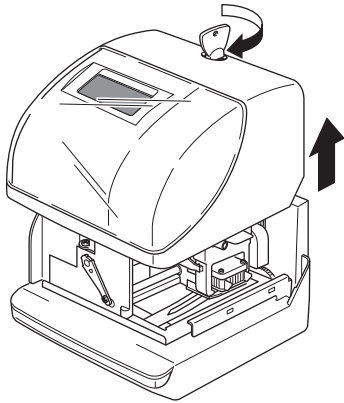

Unlock the key and remove the cover.

Step 3

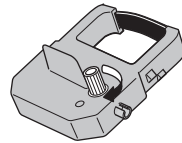

Turn the knob of the new cassette in the direction of the arrow (clockwise) to tighten the ribbon.

Step 2

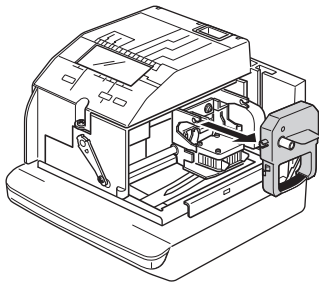

Hold the ribbon cassette by its tab and pull straight out to remove it.

Step 4

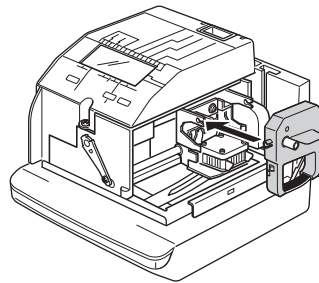

Place the cassette inside the time recorder as shown in the figure. Push the ribbon until it snaps into position. Turning the knob on the ribbon cassette may make installation easier.

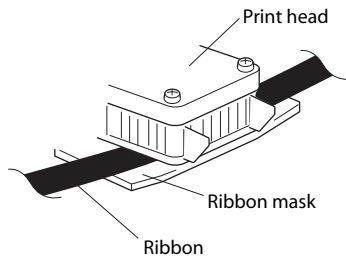

NOTICE: Install the cassette so that the ribbon is between the print head and the ribbon mask. Printing will not come out properly if the ribbon is placed behind the ribbon mask.

Step 5

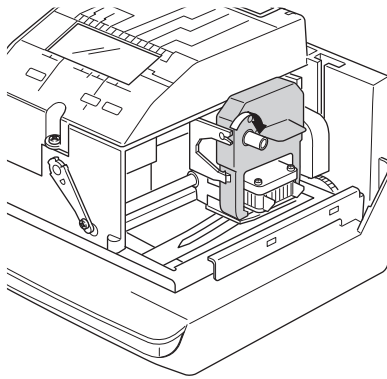

Turn the knob of the cassette in the direction of the arrow to tighten the ribbon.

Step 6

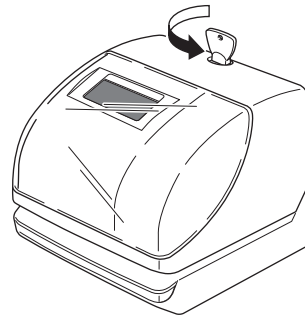

Replace the cover and lock.

TROUBLESHOOTING

Error No.	Error contents	Action
E-00	CPU error	Call the servicing dealer from whom you purchased your ES700 or call Acroprint at (800)-344-7190 (in USA).
E-01	The remaining life of lithium battery for memory back-up is short.	
E-05	The card is not inserted in the clock properly.	Correctly insert the card.
E-30	Cannot print. The printer motor or home position sensor is not normal.	Make sure that the ribbon cassette is correctly inserted in place.
E-38	Cannot print. The print head motor or the sensor does not operate properly.	Press the push bar.
E-40	Incorrect password	Enter the correct password again.
E-41	D.S.T. setting mistake	Make sure the correct starting and ending date of daylight saving time and enter again.
E-49	Setting data you entered is not usable.	Refer to your owner's manual on the page related to the item (you want to set and enter again correct setting data.)

Other Failures

- **The time clock does not operate**
Ensure the AC adapter is properly plugged into the AC outlet and AC power is available.
- **The time clock does not print**
Ensure the ribbon is installed correctly and the proper print method is set.
- **The card is jammed**
Press the push bar and try to pull out the card at the same time.

SPECIFICATIONS

Clock accuracy	Monthly accuracy ± 15 sec. (at ordinary temperatures)
Calendar	Year up to 2099. Automatically adjusted to leap years, 31-day months and months with thirty or fewer days, and the days of the week.
Printing system	Dot matrix imprint
Power failure compensation	Five years of cumulative power failure hours after the date of shipment.
Operating environment:	Temperature: +23° to 113°F, -5° to 45°C Humidity: 20% to 80%, no condensation The unit operates normally at temperatures of 41°F (5°C) or below, but the print density, reaction of the liquid crystal display, and the number of prints at power failure are inferior to those at normal temperature operation.
Dimension	6.45"(w) x 5.63"(h) x 6.77"(d), 164(w) x 143(h) x 172(d) mm
Weight	Approx. 4.4 lbs. with AC adapter (2.0 kg with AC adapter)
Power consumption	Approx. 15W, AC120V+/- 10%, 60Hz
Rating of AC adapter	I/P AC 120V/60Hz O/P AC 15.0V 1300mA

NOTICE: Use only the supplied AC adapter.