



**TIME CLOCK WORLD**

**888 534-5994**



# 8000 series

## *USER MANUAL*



## Table of Contents

SPECIFICATIONS .....	2
INTRODUCTION .....	3
REGISTRATION STYLES .....	4
REFERENCE FIGURES .....	5
INSTALLATION INSTRUCTIONS .....	6
SIGNAL WIRING DIAGRAM .....	6
GETTING STARTED .....	7
SETTING THE TYPE SECTION	
Raising and Setting the Type Section and Analog Clock .....	7
Setting the Decimal & Tenths Wheels .....	8
Dial of Decimal Equivalents .....	9
MAINTENANCE	
Changing the Ribbon .....	9
Removing the Type Section .....	10
Changing the Motor .....	10
SETTING INSTRUCTIONS FOR THE DWA 8000 SERIES .....	12
FUNCTIONS OF THE DWA 8000 SERIES KEYPAD .....	13
SETTING THE DIGITAL FACE	
Choosing a Time Format .....	14
Setting the Current Time .....	14
Setting the Current Day .....	15
PROGRAMMING SIGNAL EVENTS	
Establishing Signal Lengths .....	15
Establishing Signal Events .....	15
Deleting Signals .....	16
Sounding a Signal That Has Not Been Programmed .....	16
Enabling/Disabling Signals Globally .....	16
Reviewing Signals .....	17
POWER FAILURES .....	17
TEST/REPLACE BATTERY .....	17
WARRANTY .....	18

**WARNING:** This equipment generates, uses, and can radiate radio frequency energy and, if not installed and used in accordance with the instruction manual, may cause interference to radio communications. It has been tested and found to comply with the limits for a Class A computing device pursuant to Subpart J of part 15 of FCC Rules, which are designed to provide reasonable protection against such interference when operated in a commercial environment. Operation of the equipment in a residential area is likely to cause interference, in which case, the user, at his own expense, will be required to take whatever measures may be required to correct the interference.

## SPECIFICATIONS

### PHYSICAL

Height:	11 5/8 inches
Width:	13 inches
Depth:	12 inches
Unit Weight:	8100: 30 lbs. 3 oz. 8800: 30 lbs. 8 oz.
Case:	Lexan Polycarbonate
Color:	Grey and black with red card receiver
Power Cord Length:	6 feet

### COMPONENTS

Card Receiver:	8100: 3-1/4", 3-3/8", 4", 4-3/16" 8800: Standard 4" width, 4 3/16" width for two-column models printing month and/or year
Ribbon:	Two color nylon (red/blue)
Timing Motors:	1 RPM

### FEATURES

Display:	8100 & 8800: Analog DWA: Red, 4-Digit LED (time) 7-Segment LED (days of week)
Registration:	Automatic single or (optional) dual column with consecutive vertical alignment from top to bottom of card

### POWER REQUIREMENTS

Voltage:	115 VAC (220 VAC Optional)
Current:	9 Amp. Max. Intermittent for 115 VAC, 4 1/2 Amp. Max. Intermittent for 220 VAC
Frequency:	60 Hz (50 Hz Optional)
Battery:	DWA: 9-Volt Non-rechargeable (supplied by customer)

---

**POSSIBLE SHOCK HAZARD EXISTS WHEN CASE COVER IS REMOVED AND AC POWER IS CONNECTED. EXERCISE CAUTION WHEN SETTING TYPE SECTIONS AND TIME DISPLAYS. BE CERTAIN TO AVOID CONTACTING FOREIGN OBJECTS WITH CIRCUIT BOARDS**

---

This is a confidential proprietary document solely for the use of Latham customers. The information contained herein may not be reproduced on any media for any purpose without the written permission of Latham Time Corporation.

## INTRODUCTION

Latham time recorders are considered "standard" by thousands of businesses and institutions because of their low initial cost and years of proven, trouble-free operation. Many options are available with models to fit most business needs for payroll and job timekeeping. The 8000 Series features automatic registration, self-reversing ribbon, digital time display, coined steel type wheels, optional (8800) dual column printing and easy installation. A particularly useful feature of the DWA 8000 series is a programmable signal relay, capable of ringing bells (or other signal devices) at selected times as well as inhibiting their operation when not desired.

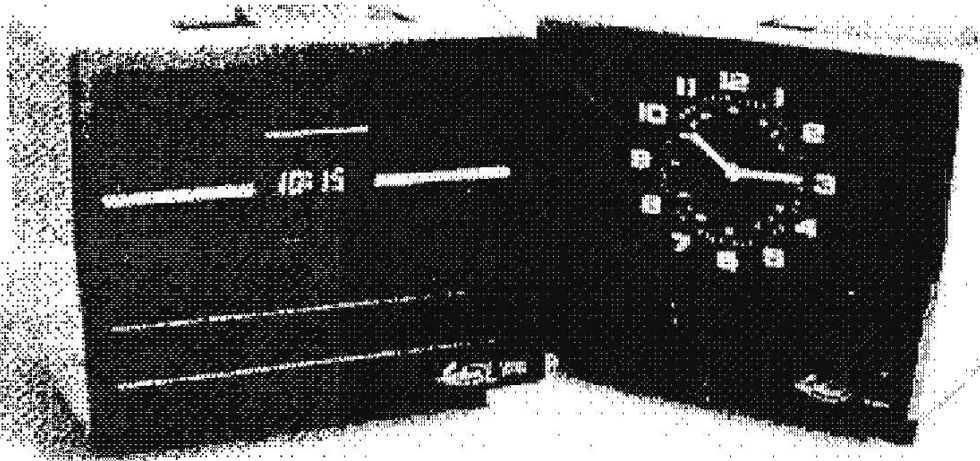

Read all directions carefully before operating or maintaining any of the 8000 Series units. Should it be necessary to return the unit, retain the original packing materials for shipping. This operations manual is designed to provide basic operating instructions. Minor maintenance and adjustments can also be performed easily and effectively by referring to these instructions. For service beyond the scope of this manual, contact the dealer from whom the equipment was purchased or Latham Time Company.

## REGISTRATION STYLES

A wide selection of registrations is available to suit the needs of any business, including: day-of-week or month-and-date; standard hours (1-12, 1-12) or continental (0-23); and minutes (00-59), tenths (.0-9), or hundredths (00-98).

<u>Models</u>	<u>Registration Style</u>
8101/8801	Date (01-31), Standard Hours (1-12, <u>1-12</u> ), Minutes (0-59)
8102/8802	Date (01-31), Standard Hours (1-12, <u>1-12</u> ), Tenths (0.0-0.9)
8103/8803	Date (01-31), Standard Hours (1-12, <u>1-12</u> ), Hndrths (00-98)
8104/8804	Date (01-31), Continental Hours (0-23), Minutes (0-59)
8105/8805	Date (01-31), Continental Hours (0-23), Tenths (0.0-0.9)
8106/8806	Date (01-31), Continental Hours (0-23), Hndrths (00-98)

Add 20 to model number for day of week registration (8801 + 20 = 8821).

8121/8821	Day of Week (SU-SA), Standard Hours (1-12, <u>1-12</u> ), Minutes (0-59)
8122/8822	Day of Week (SU-SA), Standard Hours (1-12, <u>1-12</u> ), Tenths (0.0-0.9)
8123/8823	Day of Week (SU-SA), Standard Hours (1-12, <u>1-12</u> ), Hndrths (00-98)
8124/8824	Day of Week (SU-SA), Continental Hours (0-23), Minutes (0-59)
8125/8825	Day of Week (SU-SA), Continental Hours (0-23), Tenths (0.0-0.9)
8126/8826	Day of Week (SU-SA), Continental Hours (0-23), Hndrths (00-98)

For month wheel (JA-DE), add 50 to the model number (8801 + 50 = 8851). For year wheel, add -5 suffix (8851-5). Month and year wheels are not available on models with day of week imprints. Check year wheels periodically for expiration date. Consult your dealer in advance to prevent interruption of service. Manner of column shift (optional on 8800 series) is given by first suffix letter ("O" for one-column, "M" for two-column manual shift). Card length is given by the second suffix letter ("S" for 7 inch and "L" for 9 inch). The suffix letter "W" indicates the 4 3/16 inch card receiver required for two-column models printing month and/or year.

Example: Model 8826-S uses the 7" card. Model 8851-5LW includes 9" card, and wide card receiver for month and year imprint.

**REFERENCE FIGURES**

The following reference points are located on figures 1 & 2.

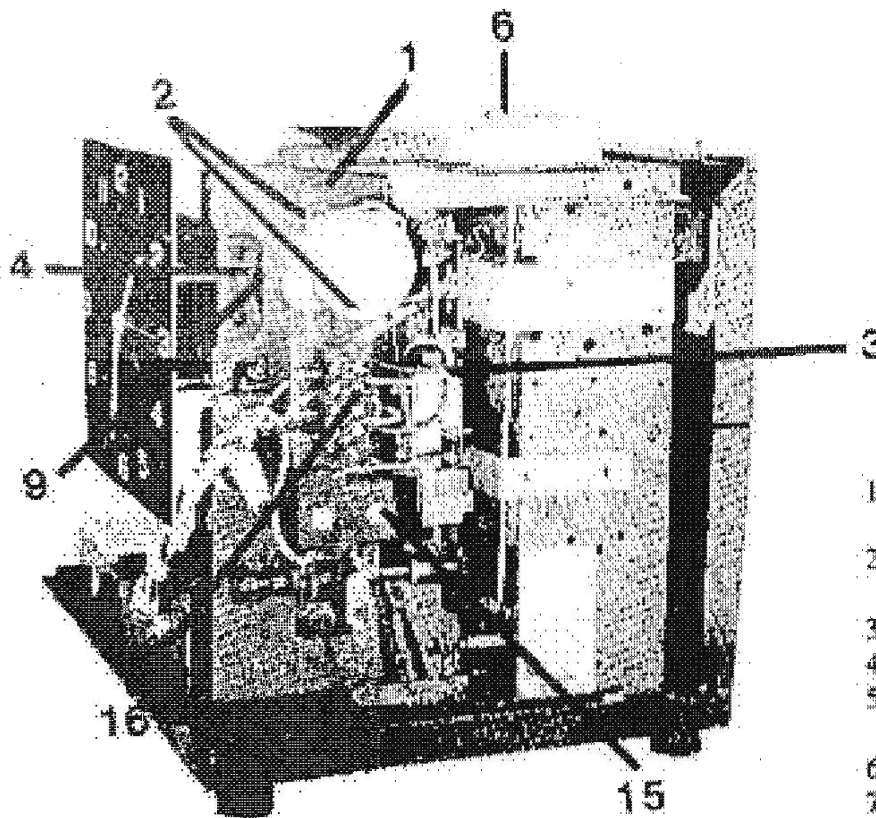

Figure 1

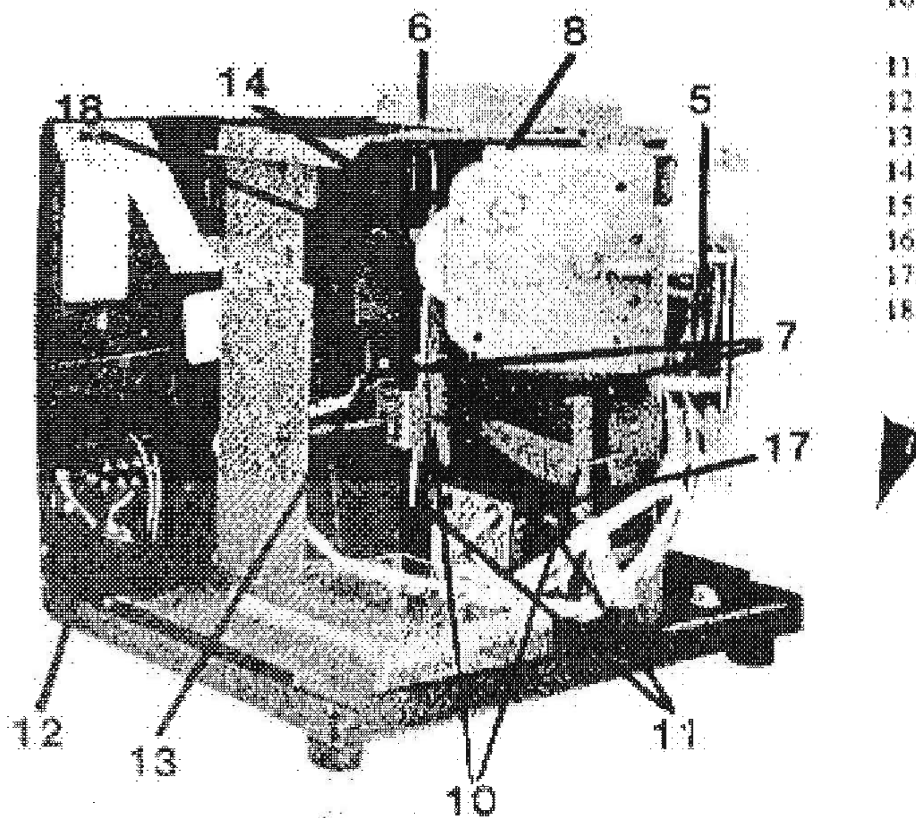

Figure 2

1. Type Section
- Unlocking Latch
2. Motor Mounting  
Screws
3. Pulse Relay
4. Main Setting Wheel
5. Face Setting Wheel  
(Analog only)
6. Card Receiver
7. Ribbon Rollers
8. Overthrow Lever
9. Motor Drive Clutch  
(Analog only)
10. Ribbon Reversing  
Fingers
11. Ribbon Spindles
12. Terminal Block
13. Trigger Switch
14. Ribbon Guide
15. Registration Switch
16. Motor Terminal Block
17. Ribbon Solenoid
18. Platen

## INSTALLATION INSTRUCTIONS

The 8000 Series can be set on a desk or shelf, or mounted on a wall. Wall mounting is recommended for payroll use because the clock can be installed at eye level (about four feet from the floor to the card receiver). **For DWA Users:** Once the clock has been installed, mount the bell(s) and horn(s) at the desired location(s). With the power cord unplugged, wire the signal devices, through a single gang outlet box, to the connector plate, mount the connector plate to the outlet box, and insert the plug of the bell cord (Figure 3).

### Typical Wiring Configuration

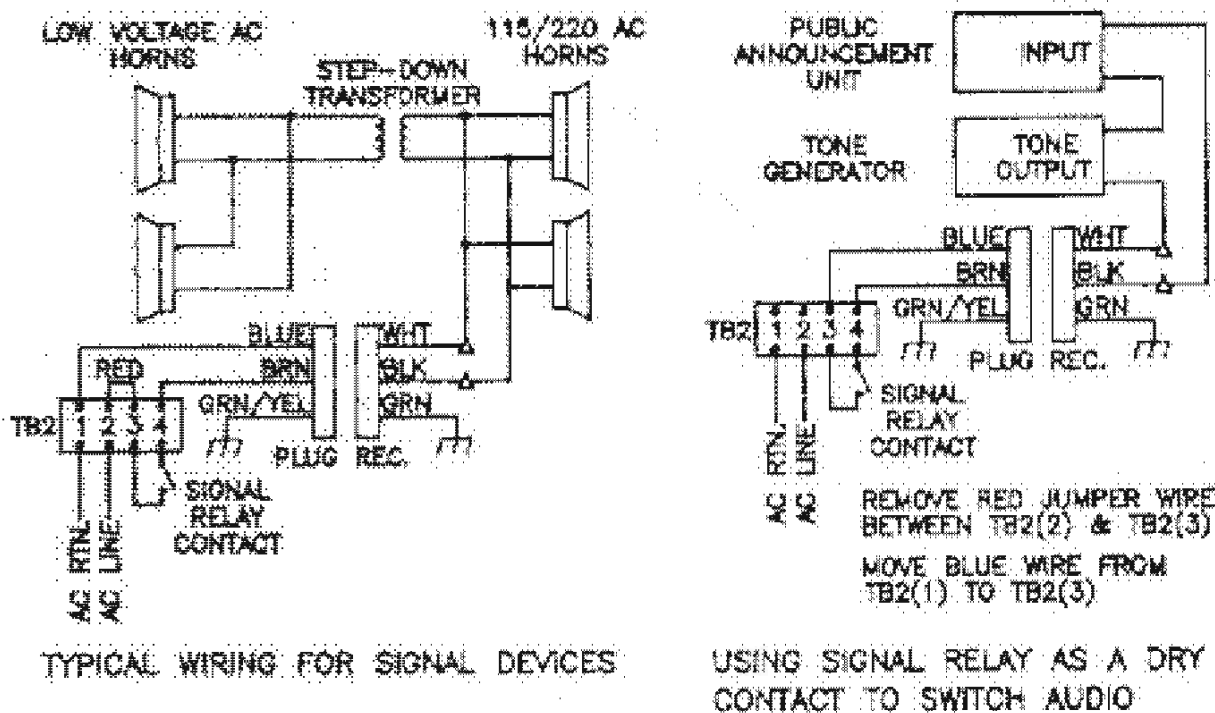

Figure 3

## GETTING STARTED

Before proceeding, you need to know the "time registration format" of your time recorder. The fourth digit in the model number indicates this format. For example, since the fourth digit in the model number 8804 is a "4", it will print the date, hours in continental (0-23) format, and minutes in 0-59 format. (See page 4)

1. Plug the clock into the wall socket.
2. Install 9 volt alkaline battery (DWA - not supplied, see page 17).
3. Set the type section. (Page 7)
4. Set the clock face. (Analog - Page 7/Digital DWA Option - Page 14)
5. Program the signals. (DWA Option - Page 15)

**THAT'S IT!** You're ready to go!

## SETTING THE TYPE SECTION

### **Raising and Setting the Type Section and Analog Clock Face**

1. Unlock the case cover and remove it by sliding it forward, away from the case.
2. Remove Type Section (see page 10 for instructions).
3. Push the Type Wheel Overthrow Lever (Figure 2, 8) down until it locks.
4. Rotate type wheels upward, one at a time, with a pointed tool such as a ballpoint pen. Move only the ratcheted-edge of the wheel to avoid damage to the type characters. Align wheels to center position. (Figure 4)

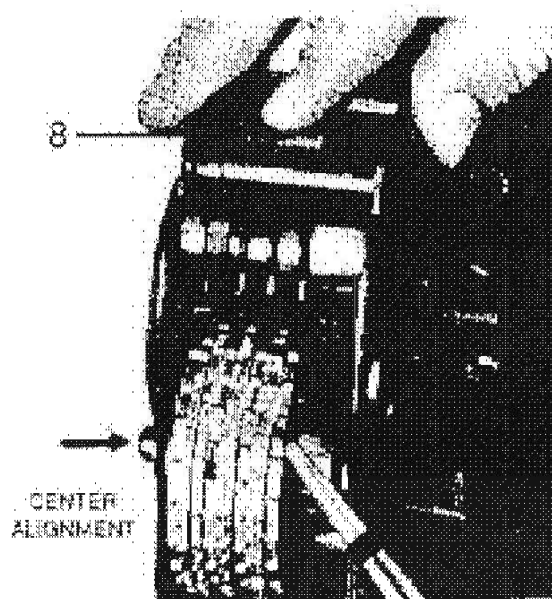

Figure 4

5. Set the day or date wheels (depending on model). If the recorder imprints month, the month wheel must be reset manually at the end of each month. In months of less than 31 days, the date wheel must be reset manually as well. Day and date wheels advance at midnight.



6. Set Minutes, Tenths or Hundredths Wheels (see model number and registration style, page 4).

If imprint is in minutes, turn minute wheels to correct setting. If imprint is in hundredths of an hour, use the Dial of Decimal Equivalents (page 9) to find desired time setting. If imprint is in tenths of an hour, see "Setting Decimal and Tenths Wheels," below.

7. Set the Hour Wheel. If imprint is in standard time (1-12, 1-12), check the AM/PM setting. For clocks with standard hours, set the hour wheel to underscored position (1-12) for PM and to non-underscored position (1-12) for AM. Improper setting will cause day or date to advance at noon rather than at midnight.
8. Rotate the Face Setting Wheel (Fig 2, 5) to advance hands on the clock face so that they coincide with the time on the type wheels. (To set DWA face, see page 14.)
9. Check that synchronized type wheels and clock face show correct time. If they do not, turn the Main Setting Wheel (Figure 1, 4) until the recorder displays the correct time.
10. Reinstall the type section, swinging it closed and locking it into place.
11. Make a sample registration to check all imprint features.
12. Replace the case cover by aligning it with tracks along case bottom, sliding toward the back of the recorder. Lock the case.

#### Setting the Decimal and Tenths Wheels

1. Rotate the Tenths Wheel and set it at "9". A wheel is set when the desired number is in line with 6:00 on the clock face.
2. Rotate Main Setting Wheel (Figure 1, 4) until the Tenths Wheel clicks over from "9" to "0".
3. Rotate Hour Wheel to set current hour.
4. Set correct minutes by rotating Main Setting Wheel one time each minute.

For example: at 10:05, rotate 5 times = 5 clicks = 5 minutes past ten o'clock.

## DIAL OF DECIMAL EQUIVALENTS

The dial to the right shows the tenths and hundredths setting for each minute. The small inner circle represents minutes, the middle circle represents tenths, and the outer circle represents hundredths.

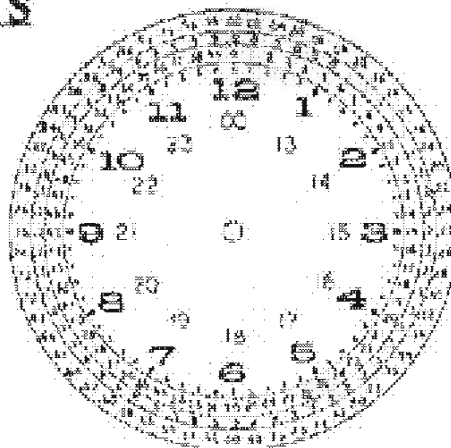

For Example: 45 minutes = 0.7 tenths = 0.75 hundredths.

Dial Of Decimal Equivalents

## MAINTENANCE

### Changing the Ribbon

Ribbon life depends on usage. However, the ribbon should be changed whenever the registration becomes faint.

1. Disconnect the AC power source.
2. Unlock the case cover and remove by sliding forward.
3. Remove Type Section (see page 10 for instructions).
4. Remove and retain cotter pins at ends of Ribbon Spindles (Fig 2, 11). Remove and discard ribbon.
5. Hold ribbon as in Figure 5, sliding ribbon spools onto ribbon spindles. Replace cotter pins.
6. Thread ribbon as in Figure 6. Ribbon reversing grommets must be under Ribbon Reversing Fingers (Fig 2, 10).

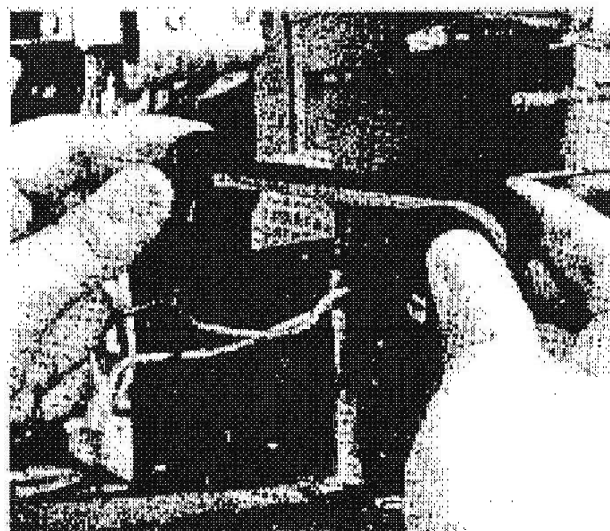

Figure 5

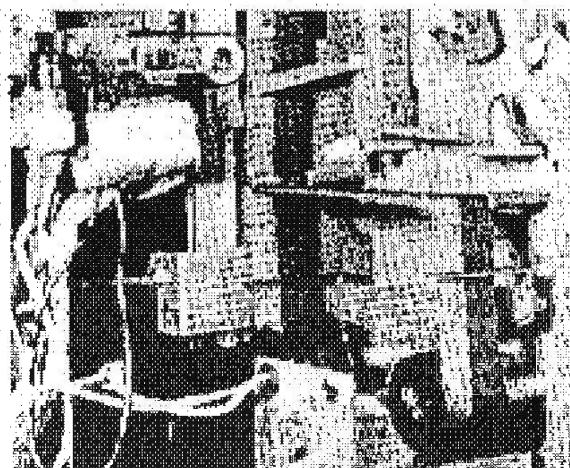

Figure 6

7. Turn spool to take up ribbon slack.
8. Re-install and reset type section.
9. Make a sample registration to check all imprint features.
10. Replace and lock case cover.

### Removing the Type Section

The type section contains all type wheels with control ratchets. The 8000 Series type sections are interchangeable and can be easily removed for repairs as follows:

1. Disconnect the AC power source.
2. Unlock case cover and remove by sliding forward.
3. Locate and press the Type Section Unlocking Latch (Figure 1, 1) with one hand and swing the type section out with the other.
4. Lift type section out of its holding brackets as shown in Figure 7.

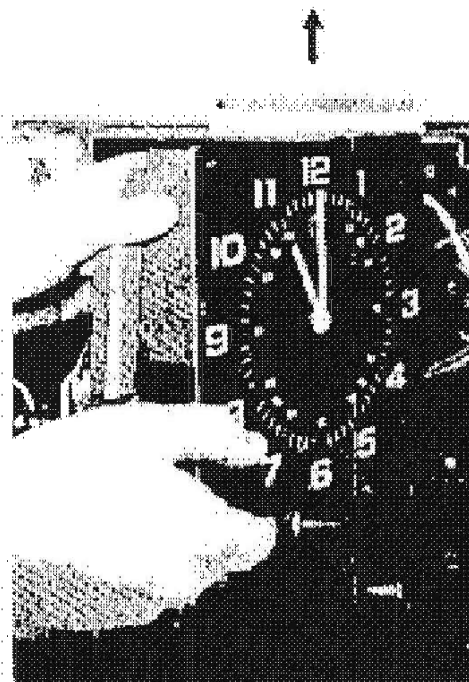

Figure 7

### Changing The Motor

Motors may be damaged by lightning, power surges, or binding type sections. No attempt should be made to repair motors. Motors are expendable and should be replaced as required. Wear is normally indicated by slowed or stopped rotation.

1. Disconnect the AC power source.
2. Unlock the case cover and remove by sliding forward.
3. Remove the type section. (see figure 7, page 10)

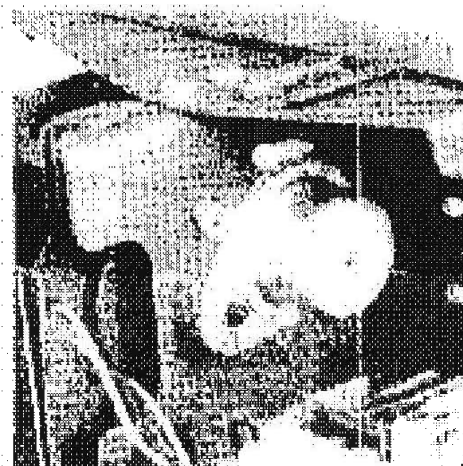

Figure 8

4. Observe the wiring of the motor into the Motor Terminal Block (Figure 1, 16). Disconnect the motor wires from the terminals.
5. Remove Motor Drive Clutch (Figure 1, 9) from motor shaft by rotating clockwise.
6. Remove and retain both motor mounting screws.
7. Remove the old motor.
8. Install the replacement motor, securing with original mounting screws.
9. Connect the motor wires to the Motor Terminal Block as before. (Figure 1, 16).
10. Turning counter-clockwise, install the motor clutch onto the new motor. Tighten only slightly or motor damage may occur.
11. Re-install the type section. The motor clutch should be checked for proper tension. Clutch legs may be slightly sprung toward either the front or the rear so that the protrusions engage with slots in the Main Setting Wheel (Figure 1, 4) without spring pressure being applied to the plate.
12. Connect AC power source.
13. Reset the type wheels and time display. (See pages 7-8)
14. Replace and lock case cover.
15. Make a sample registration to check all imprint features.

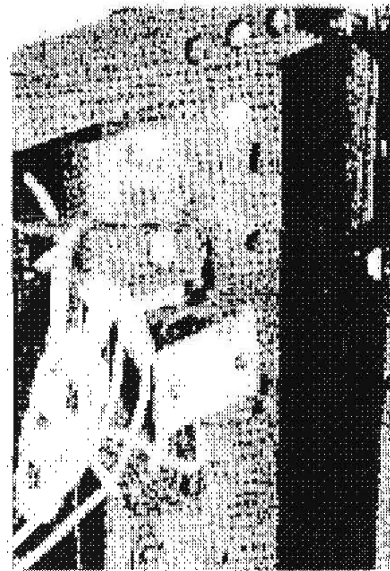
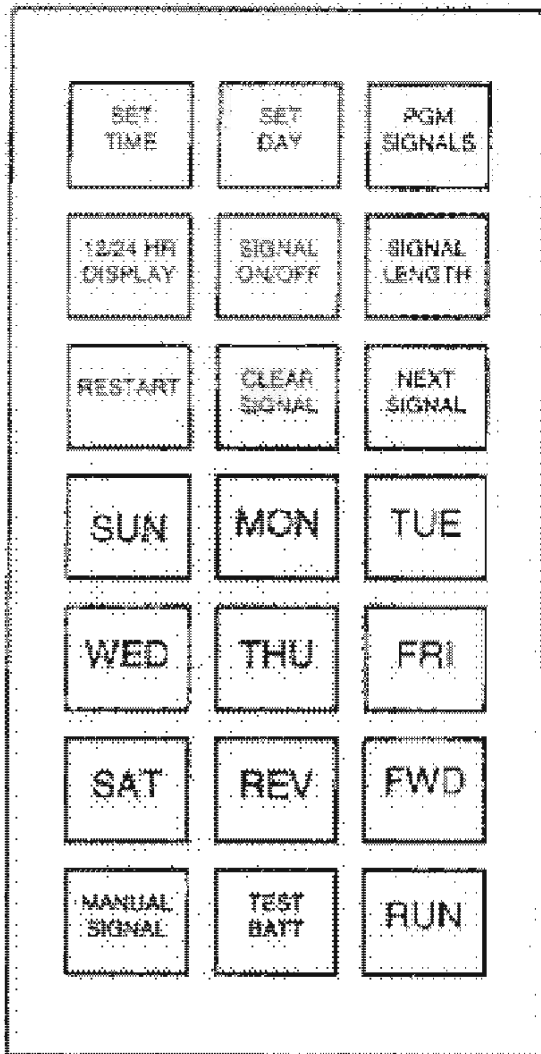

Figure 9

# SETTING INSTRUCTIONS FOR THE DWA 8000 SERIES



As in the rest of the 8000 Series, the type wheels and the clock function independently of one another. Setting the DWA 8000's digital clock does not set the type wheels. Similarly, setting the type wheels does not set the digital clock. Each assembly must be set individually and synchronized.

No security code is required to access program functions since the keypad is behind the locked cover. Unlock and remove the case cover.

## LED DISPLAY

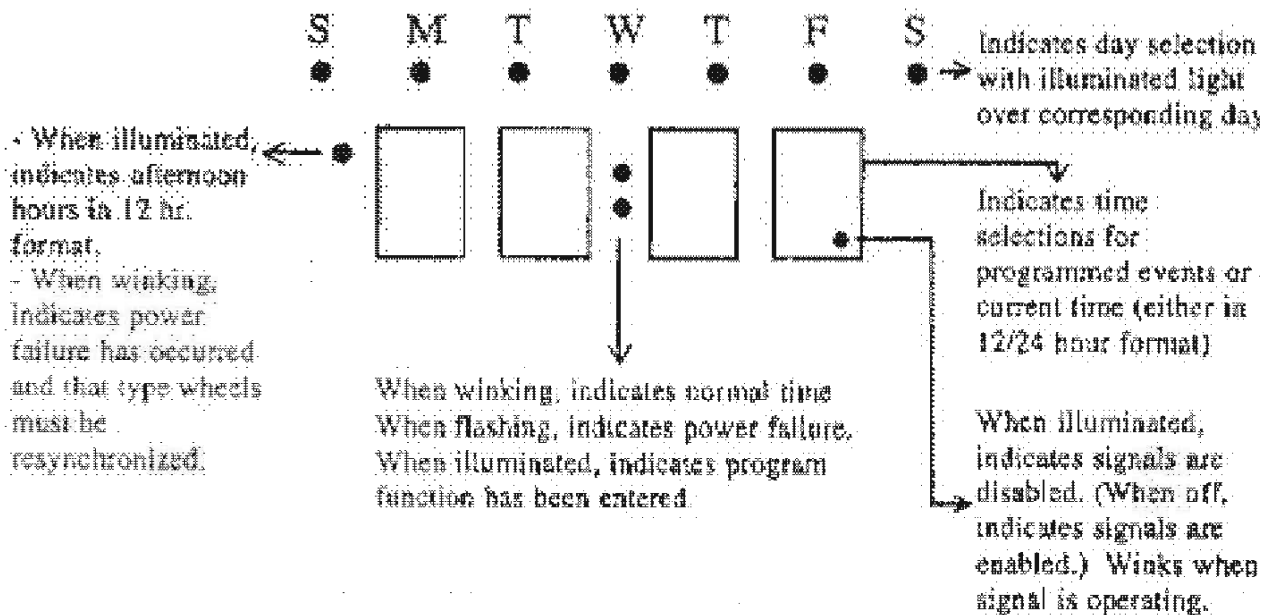

## FUNCTIONS OF THE DWA 8000 SERIES KEYPAD

SET TIME	Initiates program to set time
SET DAY	Initiates program to set day of week
PCM SIGNALS	Initiates program to set signal schedule
12/24 HR DISPLAY	Allows choice of standard or continental hour format
SIGNAL ON/OFF	Allows enabling or disabling of programmed events signals
SIGNAL LENGTH	Allows choice of duration of signal events
RESTART	Restarts the clock after a display lock-up condition, leaving all schedules intact
CLEAR SIGNAL	Deletes previously programmed event; also stops signal currently in progress
NEXT SIGNAL	Displays programmed signals from the current time forward
SUN	Allows identification of current day of the week or day(s) of the week for programmed signal events
MON	
	, ETC.
REV	Allows count-down in setting current time, times for programmed signal events, or duration of signals
FWD	Allows count-up in setting current time, times for programmed signal events, or duration of signals
MANUAL SIGNAL	Manually activates the signalling device
TEST BATT	Displays the battery's status ("Good" or "Lo")
RUN	Completes program sequence and returns clock to normal operation

## SETTING THE DIGITAL FACE





### Choosing the Time Format

The clock defaults to the 12-hour format and will appear on the display as 12:00. If the 12-hour format is desired, no action is required. If 24-hour format is desired:

1. Press  The display should read 00:00. The key toggles between the two formats. To go back to 12-hour format, press the key again.

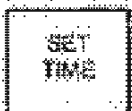
### Setting the Current Time



The clock defaults to 12 midnight.

1. Press 
2. Use a piece of heavy paper and make a registration. Remember to set the digital face to minutes regardless of the print format of the Type Section.
3. Press  or  to advance or reverse the numerals on Hr-Min face until time shown is one minutes ahead of the time shown on the registration. Minutes are advanced or reversed first, followed by the hour.
4. Listen for the wheels in the type section to click forward. When this happens, immediately press 

This will synchronize the type section with the digital display. The time is now set. Make another registration to verify that the process was completed successfully.

**Setting the Current Day**

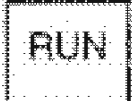

The clock defaults to Sunday.

1. Press 
2. Press   ETC. to illuminate the corresponding light.
3. Press  The day is set.



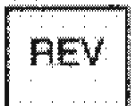
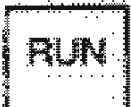

**PROGRAMMING SIGNAL EVENTS**

The user may define the occurrence, duration, and frequency of signal events. Up to 32 events, each consisting of a time and day(s) of the week. The same time on multiple days is considered one event. During an attempt to program more than 32 events, the display shows "Full" and the attempt is aborted.

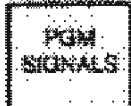

**Establishing Signal Length**

1. Press  The duration default is 5 seconds.
2. Press  or  to alter the duration of the signal until the desired duration is reached. Duration possibilities range from 01 to 99 seconds.
3. Press  The duration is set.

**Establishing Signal Events**

1. Press  The clock defaults to 12:00 midnight and will display consistent with the time format you previously selected. The colon will be illuminated and fixed, indicating the clock is in a programming mode.
2. Press  to verify that the desired signal does not exist or to quickly advance through the schedule to the event nearest the event you wish to add.
3. Press  or  To advance or reverse numerals on Hr:Min face until desired time is displayed. Minutes are advanced or reversed first, followed by the hour.







4. Press  ,  , ETC. To which corresponding signal applies.  
Light over the chosen day(s) illuminates.

Other events may be programmed by repeating steps 2 through 4. When all programs have been entered:

5. Press  The signal(s) has/have been added.

### Deleting Signals

1. Press 
2. Press  As many times as necessary to reach the identified signal to be deleted. The signals scroll from current time forward.
3. Press  to delete signal. All day LED's extinguish.
4. Press  The signal has been deleted.

### Sounding a Signal That Has Not Been Programmed

1. Press  to sound the signal. The signal will sound as long as the key is depressed.

This signal is independent of the program signals function and works in either the enabled or disabled mode. When the manual signal is operated, the disable light at the lower right of the minute display will flash.

### Enabling or Disabling Signals Globally

To toggle between all programmed signals on or all programmed signals off:

1. Press  To determine whether the programmed signals are on or off, look to the right of the minute display. If a light is illuminated, all signals are off and no signal will sound. If the light is not visible, all signals are on and will occur as programmed.

## Reviewing Signals

1. Press  to review all signals which have been installed. If no signal has been programmed, the display remains the same current time. Review starts from current time.

## POWER FAILURE

The clock's display and type section keep time according to line frequency (typically 60 Hz). During power failure, the unit automatically switches to an internal quartz crystal to maintain time. A 9-volt non-rechargeable battery maintains display time and memory for up to 15 accumulated days. When power is interrupted, the digital display disappears with the exception of the flashing colon.

When power is restored, the display indicates the correct time and day, and all programmed signals are intact. If the PM indicator is flashing when power is restored, the type wheels may need to be reset and synchronized with the time display. To verify whether or not the type wheels should be re-synchronized with the display:

1. Press  to clear the flashing PM indicator and set clock in normal mode.
2. Use a piece of heavy paper and make a registration on it by inserting it into the card receiver.
3. Compare the registration with what is shown on the display. If they match, there is no need for further action. If they don't match:
4. Go to "GETTING STARTED" on page # and follow the steps for "SETTING THE TYPE SECTION" and "SETTING THE DIGITAL FACE".

## TEST/REPLACE THE BATTERY

1. Press 

The display indicates "Good" or "Lo".

Since the battery is non-rechargeable, it should be replaced when the display indicates "Lo". (Figure 10)

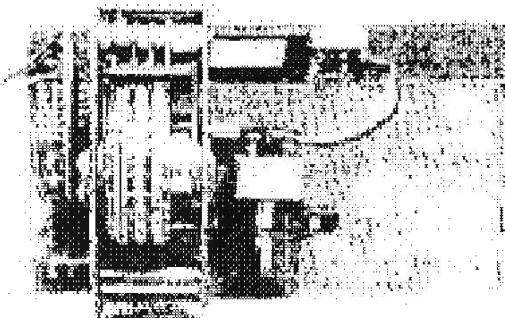

Figure 10

---

**LATHEM ONE YEAR LIMITED WARRANTY**

This Lathem product is warranted against defects in material and workmanship for a period of one year from the date of original purchase. The conditions of this warranty and the extent of the responsibility of Lathem Time Company ("Lathem") under this warranty are as follows:

1. This warranty will become void when service, performed by anyone other than an approved Lathem warranty service dealer, results in damage to the product.
2. This warranty does not apply to any product which has been subject to abuse, neglect or accident, or which has had the serial number altered or removed, or which has been connected, installed, adjusted or repaired other than in accordance with instructions furnished by Lathem.
3. This warranty does not cover dealer labor cost for removing and reinstalling the machine for repair, or any expendable parts that are readily replaced due to normal use.
4. The sole responsibility of Lathem under this warranty shall be limited to repair of this product, or replacement thereof, at the sole discretion of Lathem.
5. If it becomes necessary to send the product or any defective part to Lathem or any authorized service dealer, the product must be shipped in its original carton or equivalent, fully insured, with shipping charges prepaid. Lathem will not assume any responsibility for any loss or damage incurred during shipping.
6. **WARRANTY DISCLAIMER: LIMITATION OF LIABILITY. EXCEPT IN ONLY THE LIMITED EXPRESS WARRANTY SET FORTH ABOVE, THERE ARE NO WARRANTIES, EXPRESSED OR IMPLIED, REGARDING THIS PRODUCT. LATHEM SPECIFICALLY DISCLAIMS THE IMPLIED WARRANTIES OF MERCHANTABILITY LIABLE FOR ANY DIRECT, SPECIAL OR CONSEQUENTIAL DAMAGES ARISING OUT OF OR IN CONNECTION WITH THE DELIVERY, USE OR INABILITY TO USE, OR PERFORMANCE OF THIS PRODUCT.**
7. Proof of date of purchase will be required for warranty service on this product.
8. **THIS WARRANTY GRANTS SPECIFIC LEGAL RIGHTS. ADDITIONAL LEGAL RIGHTS, WHICH VARY FROM STATE TO STATE, MAY ALSO APPLY.**
9. Should any difficulties arise with the performance of this product during warranty, or with any Lathem authorized service centers

LATHEM TIME CORPORATION